

User Manual

N Series 1U LCD Keyboard Drawer 17", 19" screen size



Models N-117 / 119 Series

- With KVM options



Models NS-117 / 119 Series

- With KVM Options
- 1U 17", 19" screen size
- Designed for SUN Solaris



Models N-1417 / 1419 Series

- Short depth version
- Without KVM options

Contents

Chapter 1 **Getting Started**

1.1	Important Safeguards.....	1
1.2	Regulatory Notice.....	2
1.3	Package Contents.....	3
1.4	Before Installation.....	4
1.5	Unpacking.....	4
1.6	Optional Accessories.....	4
1.7	Peripheral Products.....	5
1.8	Structure Diagram.....	5
1.9	How to Install “One Man” Installation Slides.....	6-7
1.10	How to Use The Slides.....	8
1.11	How to Use “N” Series LCD Keyboard Drawer.....	9
1.12	NS-117 / 119 (Single console) - Use CB-6 to connect to server via USB interface.....	10
1.13	NS-117 / 119 (Single console) - Use CB-6 to connect to KVM via USB interface.....	10
1.14	N-117 / 119 / 1417 / 1419 (Single console) - Use CE-6 to connect to server via PS/2 interface.....	11
1.15	N-117 / 119 / 1417 / 1419 (Single console) - Use CE-6 to connect to KVM via PS/2 interface.....	11
1.16	N-117 / 119 / 1417 / 1419 (Single console) - Use CE-6 to connect to server via USB interface.....	12
1.17	N-117 / 119 / 1417 / 1419 (Single console) - Use CE-6 to connect to KVM via USB interface.....	12

Chapter 2 **Operation**

2.1	On-screen Display Operation.....	13
2.2	On-screen Menu.....	14

Chapter 3 **Standard Specification**

3.1	Specifications.....	15
3.2	Keyboard & Mouse.....	16-17
3.3	How to Use “NS” Keyboard.....	18

Contents

Chapter 4	Optional Specification	
4.1	KVM Options.....	19
4.2	DVI-D Input Option.....	19
4.3	BNC + S-Video Option.....	19
4.4	Audio Option.....	20
4.5	DC power Options.....	20
Chapter 5	Troubleshooting	21
Chapter 6	Dimensions	22

1.1 Important Safeguards

Chapter 1

Please read all of these instructions carefully before you use the device. Save this manual for future reference.

What the warranty does not cover

- Any product, on which the serial number has been defaced, modified or removed.
- Damage, deterioration or malfunction resulting from:
 - Accident, misuse, neglect, fire, water, lightning, or other acts of nature, unauthorized product modification, or failure to follow instructions supplied with the product.
 - Repair or attempted repair by anyone not authorized by us.
 - Any damage of the product due to shipment.
 - Removal or installation of the product.
 - Causes external to the product, such as electric power fluctuation or failure.
 - Use of supplies or parts not meeting our specifications.
 - Normal wear and tear.
 - Any other causes which does not relate to a product defect.
- Removal, installation, and set-up service charges.

Legal Information

First English printing, October 2002

Information in this document has been carefully checked for accuracy; however, no guarantee is given to the correctness of the contents. The information in this document is subject to change without notice. We are not liable for any injury or loss that results from the use of this equipment.

Safety Instructions

- Unplug equipment before cleaning. Don't use liquid or spray detergent; use a moist cloth.
- Keep equipment away from excessive humidity and heat. Preferably, keep it in an air-conditioned environment with temperatures not exceeding 40° Celsius (104° Fahrenheit).
- When installing, place the equipment on a sturdy, level surface to prevent it from accidentally falling and causing damage to other equipment or injury to persons nearby.
- When the drawer is in an open position, do not cover, block or in any way obstruct the gap between it and the power supply. Proper air convection is necessary to keep it from overheating.
- Arrange the equipment's power cord in such a way that others won't trip or fall over it.
- If you are using a power cord that didn't ship with the equipment, ensure that it is rated for the voltage and current labeled on the equipment's electrical ratings label. The voltage rating on the cord should be higher than the one listed on the equipment's ratings label.
- Observe all precautions and warnings attached to the equipment.
- If you don't intend on using the equipment for a long time, disconnect it from the power outlet to prevent being damaged by transient over-voltage.
- Keep all liquids away from the equipment to minimize the risk of accidental spillage. Liquid spilled on to the power supply or on other hardware may cause damage, fire or electrical shock.
- Only qualified service personnel should open the chassis. Opening it yourself could damage the equipment and invalidate its warranty.
- If any part of the equipment becomes damaged or stops functioning, have it checked by qualified service personnel.

Regulatory Notices Federal Communications Commission (FCC)

This equipment has been tested and found to comply with the limits for a Class B digital device, pursuant to Part 15 of the FCC rules. These limits are designed to provide reasonable protection against harmful interference in a residential installation.

Any changes or modifications made to this equipment may void the user's authority to operate this equipment. This equipment generates, uses, and can radiate radio frequency energy and, if not installed and used in accordance with the instructions, may cause harmful interference to radio communications.

However, there is no guarantee that interference will not occur in a particular installation. If this equipment does cause harmful interference to radio or television reception, which can be determined by turning the equipment off and on, the user is encouraged to try to correct the interference by one or more of the following measures:

- Re-position or relocate the receiving antenna.
- Increase the separation between the equipment and receiver.
- Connect the equipment into an outlet on a circuit different from that to which the receiver is connected.

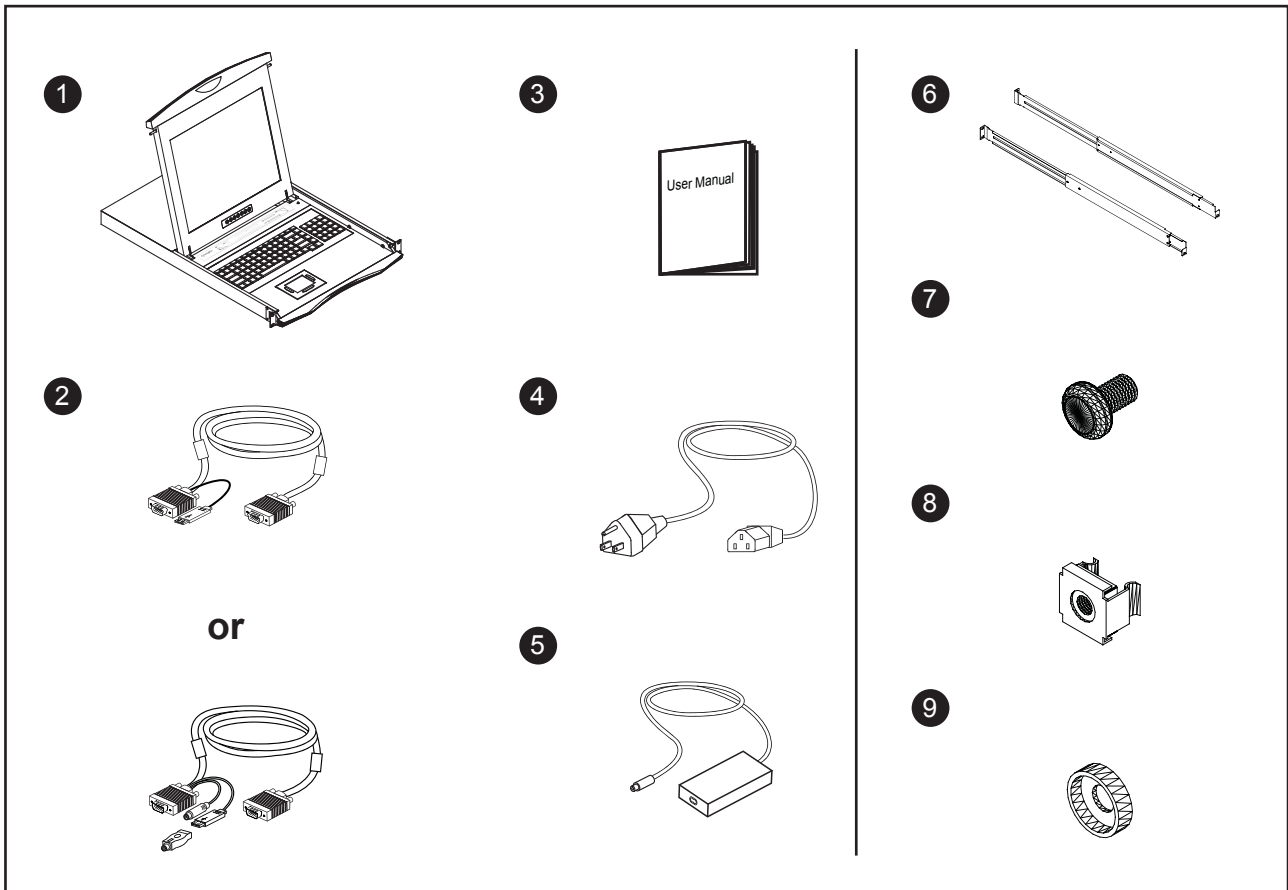

- ① LCD keyboard drawer x 1 pc
- ② **CB-6** USB 2-in-1 KVM cable x 1 pc (for NS series) **OR**
CE-6 Combo 4-in-1 KVM cable x 1 pc (for N series)
- ③ User manual x 1 pc
- ④ Power cord x 1 pc
- ⑤ Auto switch power adapter (for external power version) x 1 pc
- ⑥ Mounting bracket x 2 pcs
- ⑦ M6*15mm screw x 8 pcs
- ⑧ M6 cage nut x 6 pcs
- ⑨ Cup washer x 8 pcs

- It is very important to locate the LCD Keyboard Drawer in a suitable environment.
- The surface for placing and fixing the LCD Keyboard Drawer should be stable and level or mounted into a suitable cabinet.
- Make sure the place has good ventilation, is out of direct sunlight, away from sources of excessive dust, dirt, heat, water, moisture and vibration.
- Position LCD Keyboard Drawer with respect to related facilities.

1.5 Unpacking

The LCD keyboard drawer comes with the standard parts shown on the package contents. Check and make sure they are included and in good condition. If anything is missing, or damage, contact the supplier immediately.

1.6 Optional Accessories

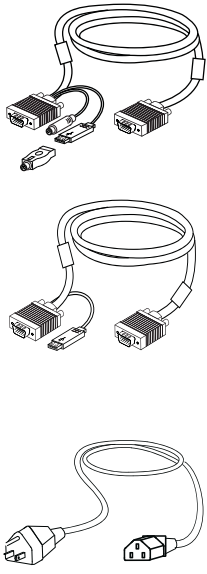
<p>1. Combo 4-in-1 KVM cable</p> <ul style="list-style-type: none">1.1 CE-6 6 feet1.2 CE-10 10 feet1.3 CE-15 15 feet <p>2. USB 2-in-1 KVM cable</p> <ul style="list-style-type: none">2.1 CB-6 6 feet2.2 CB-10 10 feet2.3 CB-15 15 feet <p>3. Power Cord</p> <ul style="list-style-type: none">3.1 IEC power cord3.2 NEMA 5-15 power cord (US)3.3 BS 1363 power cord (UK)3.4 CEE 7/4 power cord (German)3.5 AS 3112 power cord (Australia)	
---	---

Remarks :

- CB-6 is for NS series only.

Item	Model No.	Description
Matrix Cat6 KVM	MU-1602 / MU-1603 / MU-1604	Matrix Cat6 16 port KVM
	MU-IP1613 / MU-IP1614 / MU-IP1624	Matrix IP Cat6 16 port KVM
	MU-3202 / MU-3203 / MU-3204	Matrix Cat6 32 port KVM
	MU-IP3213 / MU-IP3214 / MU-IP3224	Matrix IP Cat6 32 port KVM
Matrix DB-15 KVM	M-802 / M-803 / M-804	Matrix DB-15 8 port KVM
	M-IP813 / M-IP814 / M-IP824	Matrix IP DB-15 8 port KVM
	M-1602 / M-1603 / M-1604	Matrix DB-15 16 port KVM
	M-IP1613 / M-IP1614 / M-IP1624	Matrix IP DB-15 16 port KVM
Combo Cat6 KVM	U-801 / U-802 / U-IP802	Combo Cat6 8 port KVM
	U-1601 / U-1602 / U-IP1602	Combo Cat6 16 port KVM
	U-3201 / U-3202 / U-IP3202	Combo Cat6 32 port KVM
Combo DB-15 KVM	CV-S801 / CV-802 / IP-802	Combo DB-15 8 port KVM
	CV-S1601 / CV-1602 / IP-1602	Combo DB-15 16 port KVM
PS/2 DB-15 KVM	CV-401 / CV-801 / CV-1601	4 / 8 / 16 port PS/2 DB-15 KVM

Remarks :

- “NS” Series is for Matrix & Combo KVM only.

1.8 Structure Diagram

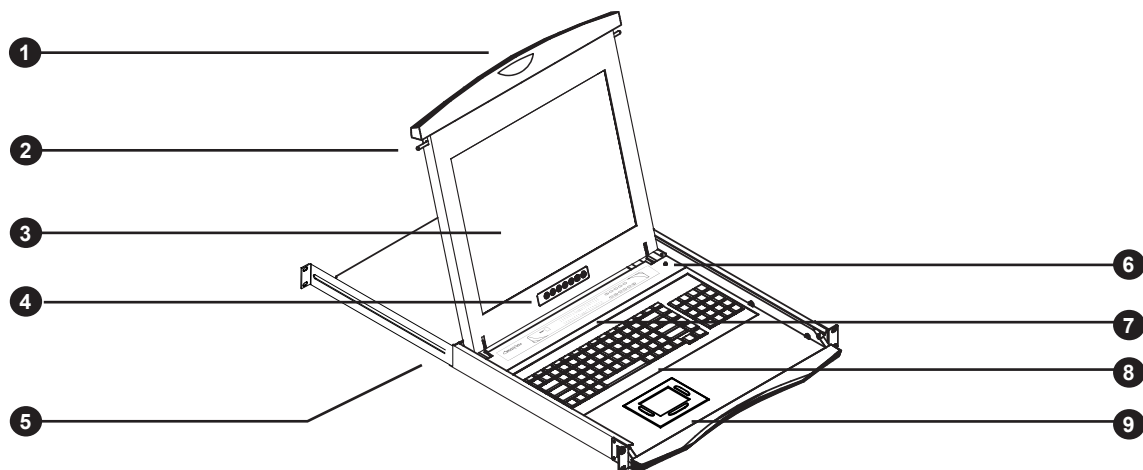

- | | |
|---|--|
| ① Carry handle to release the 2-pt lock | ⑥ Micro switch for screen auto power off |
| ② 2-point lock | ⑦ Membrane switch (KVM option) |
| ③ LCD interchangeable module kit | ⑧ Keyboard interchangeable module kit |
| ④ LCD membrane | ⑨ Mouse interchangeable module kit |
| ⑤ “One Man” Installation Slides | |

Install into rack

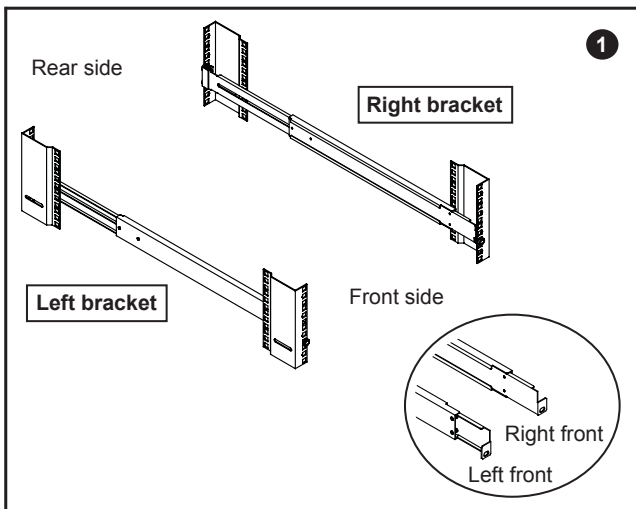

- Attach the left and right mounting bracket to rack 19" mounting rails.
- Adjust the rear mounting bracket to fit your rack.
- M6 screw and cup washer x 6 pcs included.

Caution : Leaving the screws slightly loose, until you complete the installation in step 4

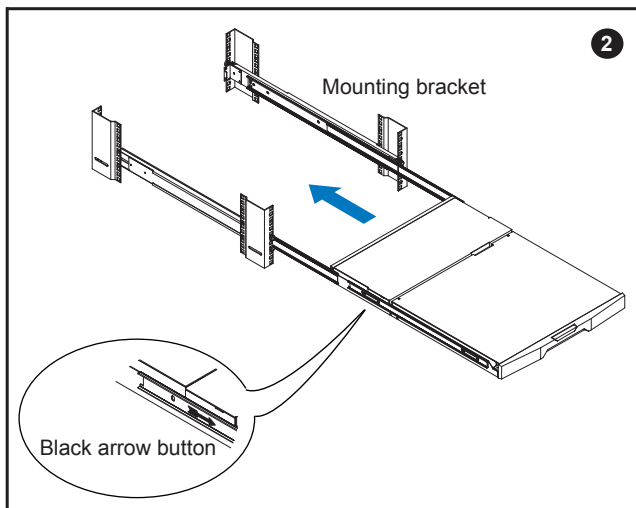

- Pick up the LCD keyboard drawer.
- Insert the LCD keyboard drawer into the mounting bracket.
- Pull and hold the left & right black arrow buttons on the rails.
- Return the LCD keyboard drawer to park position.

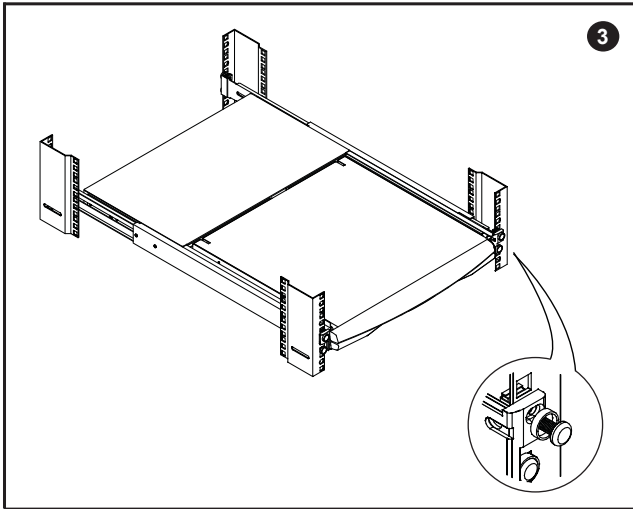

- Attach front left and right mounting ears of the LCD keyboard drawer to vertical mounting rails.
- M6 screw and cup washer x 2 pcs included.

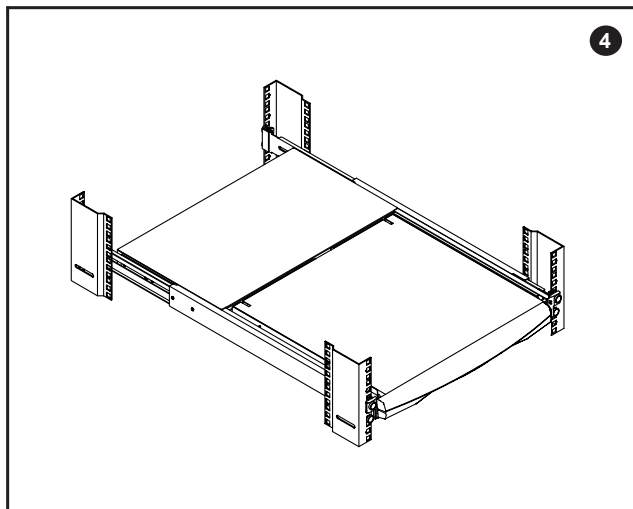

Complete the installation

- Tighten all 8 pcs of M6 screw to complete the installation.

Remarks :

- NBK-01 is for N-117 / 119 & NS-117 / 119 series only.
- NBK-02 is for N-1417 / 1419 series only.
- Installation procedures of NBK-02 are same to that of NBK-01.

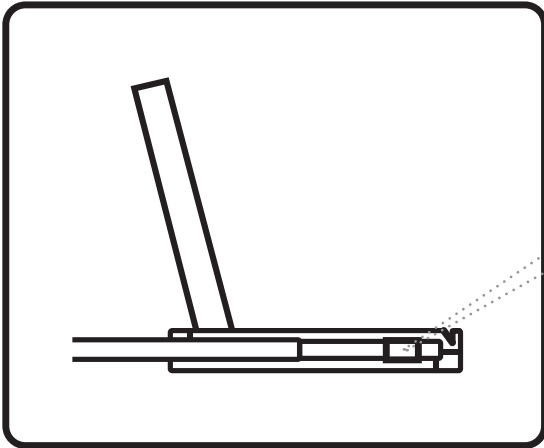

Figure 1.

- A black arrow release button is located on the outside of each slide. (shown in **Figure 1**).

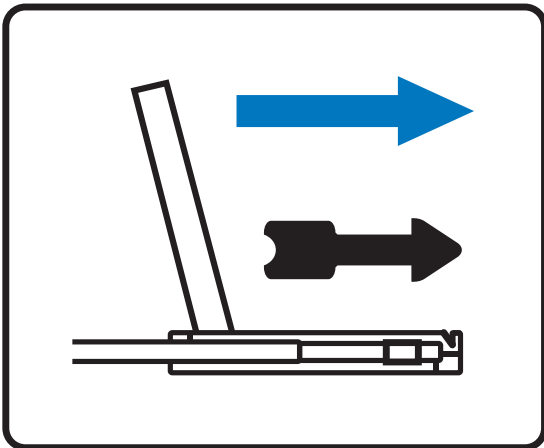

Figure 2.

- Pull and hold the black arrow button on either side of the LCD keyboard drawer to unlock. (shown in **Figure 2**).

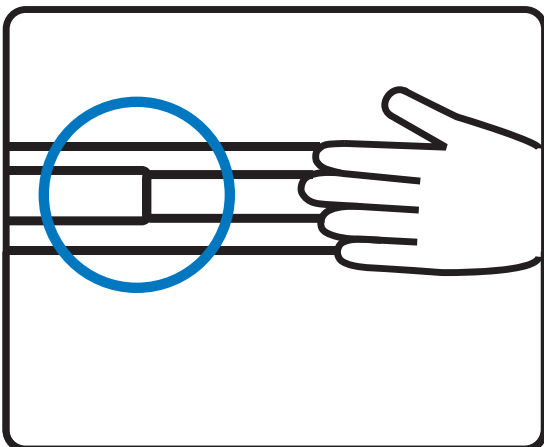

Figure 3.

- Push the LCD keyboard drawer into the rack. (shown in **Figure 3**).

 **Caution** : Keep your fingers away from the slide stop



Figure 4. Pulling the tab toward the front of LCD.

- Gently pull the tab toward the front of the LCD shown in **Figure 4**.



Figure 5. Flipping up the LCD to a suitable angle.

- Flip up the LCD to a suitable angle shown in **Figure 5**.



Figure 6. Operating the LCD keyboard drawer

- Operate the LCD keyboard drawer shown in **Figure 6**.

1.12 NS-117 / 119 (Single console)

- Use CB-6 to connect to server via USB interface

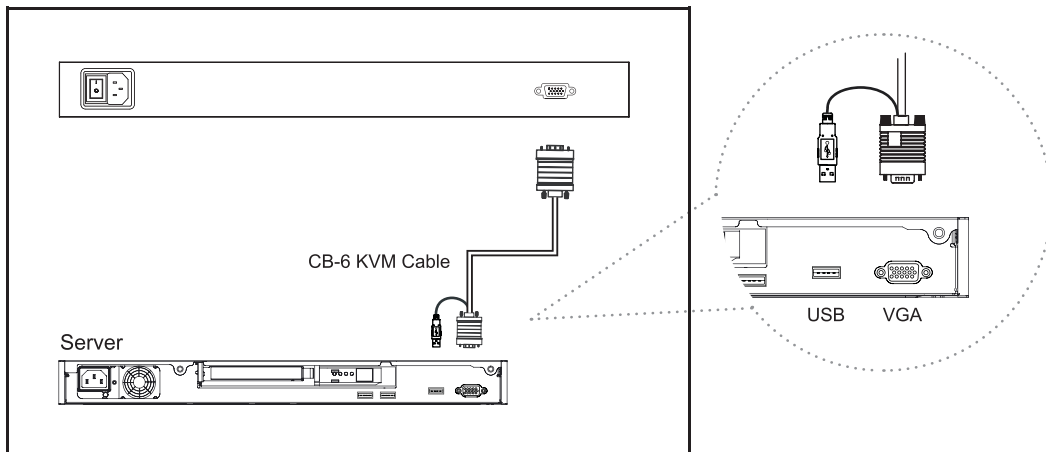

Figure 7. Example of connecting CB-6 2-in-1 USB KVM cable to server via USB interface

1.13 NS-117 / 119 (Single console)

- Use CB-6 to connect to KVM via USB interface

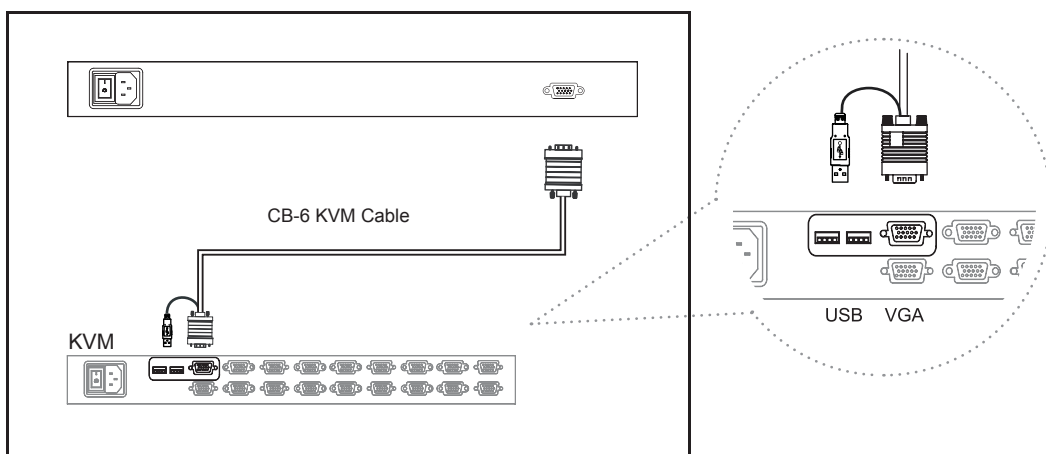

Figure 8. Example of connecting CB-6 2-in-1 USB KVM cable to KVM via USB interface

Remarks :

- The above connection is only for the LCD keyboard without KVM switch built-in.
- For the LCD keyboard drawer with KVM switch built-in, please refer to attached KVM switch user manual.



Caution : The LCD keyboard drawer is hot-pluggable, but components of connected devices, such as the servers and KVM switch, may not be hot-pluggable. Plugging and unplugging cables while servers and KVM are powered on may cause irreversible damage to the servers, KVM and LCD keyboard drawer. Before attempting to connect anything to the LCD keyboard drawer, we suggest turning off the power to all devices before connecting them. Apply power to connected devices again only after the LCD keyboard is receiving power. The company is not responsible for damage caused in this way.

1.14 N-117 / 119 / 1417 / 1419 (Single console) - Use CE-6 to connect to server via PS/2 interface

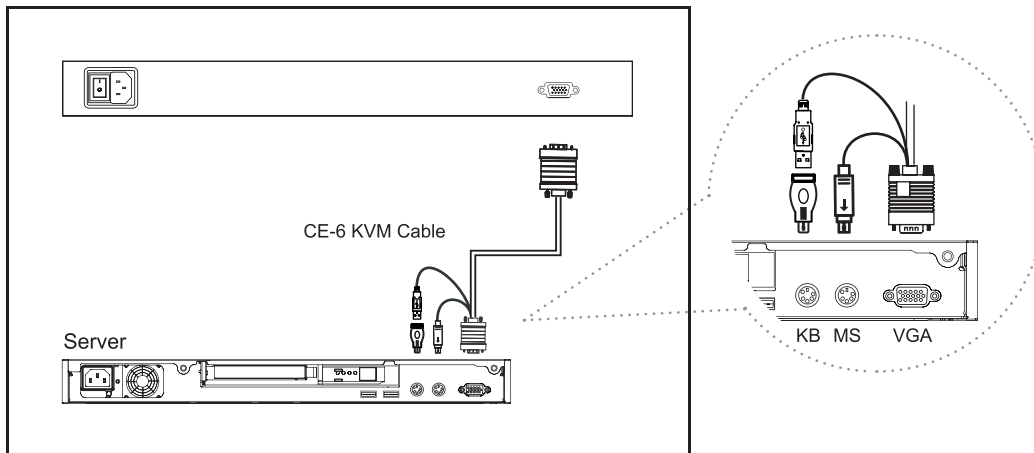

Figure 9. Example of connecting CE-6 Combo 4-in-1 KVM cable to server via PS/2 interface

1.15 N-117 / 119 / 1417 / 1419 (Single console) - Use CE-6 to connect to KVM via PS/2 interface

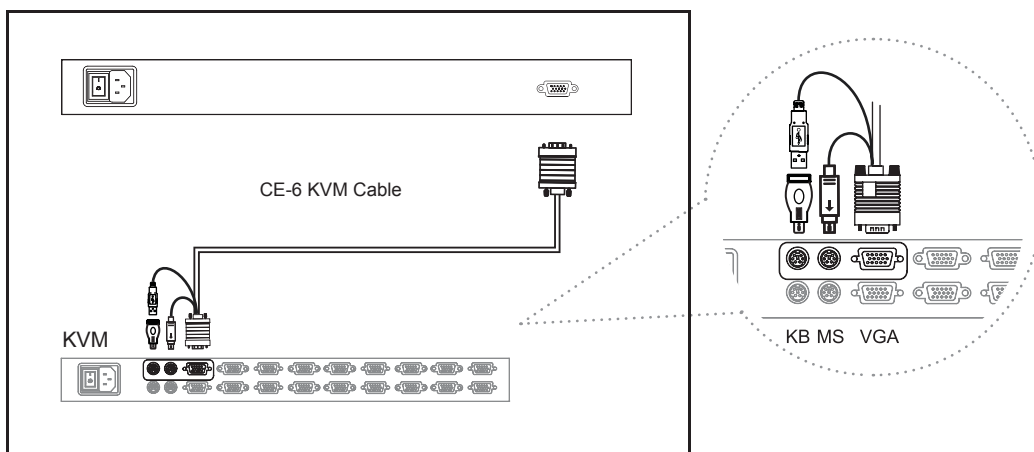

Figure 10. Example of connecting CE-6 Combo 4-in-1 KVM cable to KVM via PS/2 interface

Remarks :

- N-1417 / 1419 series are external power versions.
- The above connection is only for the LCD keyboard without KVM switch built-in.
- For the LCD keyboard drawer with KVM switch built-in, please refer to attached KVM switch user manual.



Caution : The LCD keyboard drawer is hot-pluggable, but components of connected devices, such as the servers and KVM switch, may not be hot-pluggable. Plugging and unplugging cables while servers and KVM are powered on may cause irreversible damage to the servers, KVM and LCD keyboard drawer. Before attempting to connect anything to the LCD keyboard drawer, we suggest turning off the power to all devices before connecting them. Apply power to connected devices again only after the LCD keyboard is receiving power. The company is not responsible for damage caused in this way.

1.16 N-117 / 119 / 1417 / 1419 (Single console) - Use CE-6 to connect to server via USB interface

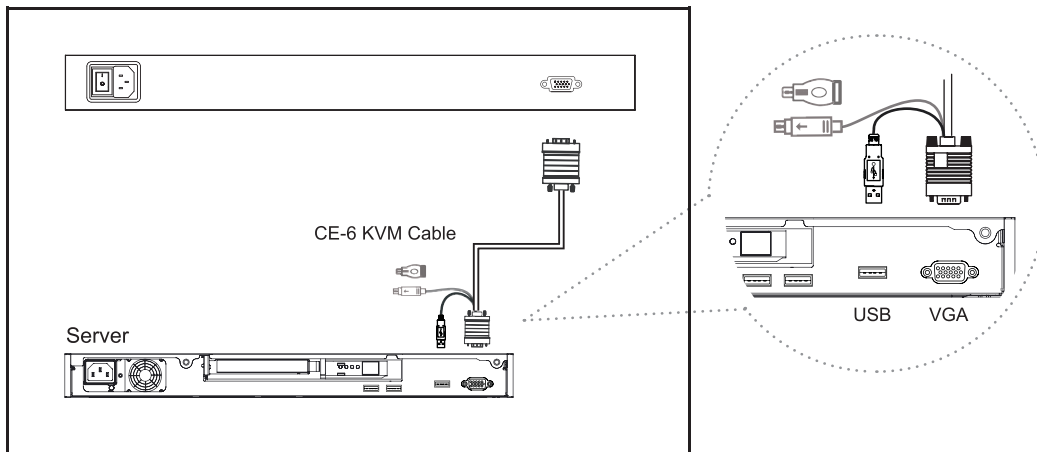

Figure 11. Example of connecting CE-6 Combo 4-in-1 KVM cable to server via USB interface

1.17 N-117 / 119 / 1417 / 1419 (Single console) - Use CE-6 to connect to KVM via USB interface

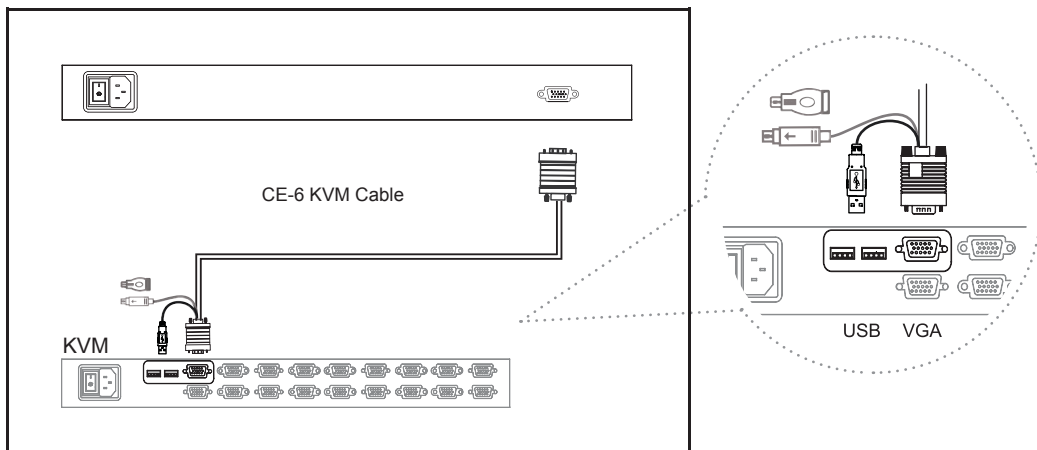

Figure 12. Example of connecting CE-6 Combo 4-in-1 KVM cable to KVM via USB interface

Remarks :

- N-1417 / 1419 series are external power versions.
- The above connection is only for the LCD keyboard without KVM switch built-in.
- For the LCD keyboard drawer with KVM switch built-in, please refer to attached KVM switch user manual.



Caution : The LCD keyboard drawer is hot-pluggable, but components of connected devices, such as the servers and KVM switch, may not be hot-pluggable. Plugging and unplugging cables while servers and KVM are powered on may cause irreversible damage to the servers, KVM and LCD keyboard drawer. Before attempting to connect anything to the LCD keyboard drawer, we suggest turning off the power to all devices before connecting them. Apply power to connected devices again only after the LCD keyboard is receiving power. The company is not responsible for damage caused in this way.

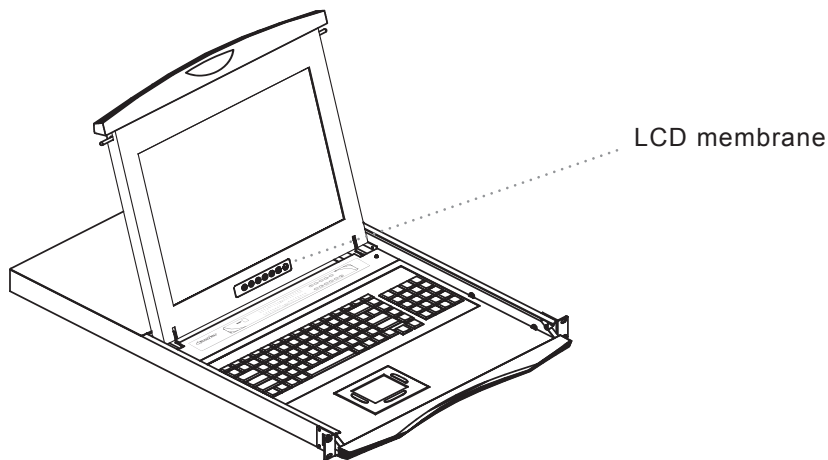

Membrane Switch	Function
	Power light Green = On Orange = Power saving
	Power on / off LCD
	Display the OSD menu
	Scrolls through menu options and adjusts the displayed control (To auto adjustment by pressing the button for 5 seconds)
	Exit the OSD screen Toggle analog, digital & video connection (DVI-D and video options only)

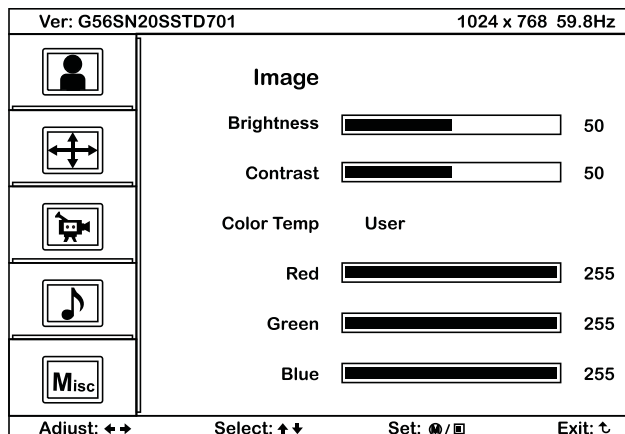

OSD Configuration Page



Image:

To enter into the brightness, contrast, color temp, red, green, and blue

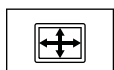

Geometry:

To enter into the auto adjust, H position, V position, phase and clock



Video:

To enter into the colour, tint, sharpness, noise reduction, DCDi and TV Setup



Audio:

To enter into volume, bass, treble, balance, AVL and mute



Misc:

To enter into the language, OSD position, graphic mode, ratio, reset and timer

Item	Description			
Form Factor	1U rack mounting on slide-out rails			
LCD Manufacturer			-	
Series	N		NS	
Diagonal Size	17" TFT	19" TFT	17" TFT	19" TFT
Max. Resolution	1280 x 1024	1280 x 1024	1152 x 900 (Direct) 1280 x 1024 (Native)	1152 x 900 (Direct) 1280 x 1024 (Native)
Brightness (cd/m ²)	250	250	250	250
Color Support	16.7 M	16.7 M	16.7 M	16.7 M
Contrast Ratio (typ.)	1000:1	1000:1	1000:1	1000:1
Viewing Angle (H/V)	160° x 160°	160° x 160°	160° x 160°	160° x 160°
Display Area (mm)	338 x 270	376 x 301	338 x 270	376 x 301
Tr Response Time (ms)	1.3	1.3	1.3	1.3
LCD Panel MTBF (hrs)	50,000	50,000	50,000	50,000
VGA Signal Input	Analog RGB, 0.7Vp-p			
Sync. Type	Separate H/V, Composite, SOG			
Resolution	720 x 400, 70Hz			
	640 x 480, 60/ 70/ 72/ 75Hz			
	800 x 600, 60/ 70/ 72/ 75Hz			
	1024 x 768, 60/ 70/ 75Hz			
	1152 x 864, 60/ 70/ 75Hz			
	1280 x 720, 60/ 70/ 75Hz		1280 x 720, 60/ 75Hz	
	1280 x 1024, 60/ 70/ 72/ 75Hz		1280 x 1024, 60/ 70/ 75Hz	
	-		1152 x 900, 66/ 76Hz	
Plug & Play DDC	EDID 1.3			
Console Port	DB-15 connector for VGA / keyboard / mouse (Combo interface)		DB-15 connector for VGA / keyboard / mouse Support USB servers or Combo KVM switches	
Power Input	Auto-sensing 100 to 240VAC, 50 / 60Hz			
Power Consumption	Max. 48 Watt, Standby 5 Watt			
Compatibility	Multi-platform - Mix PCs, SUNs, IBMs, HPs & DELLs.			
Regulation Approval	FCC, CE			

Options

KVM Integration	Matrix & combo KVM with IP console and 2-console selection		
Keyboard & mouse	Full size keyboard built-in touch-pad / trackball	SUN-compatible keyboard integrated with 3-button touchpad / trackball	
Graphic Input	DVI-D, S-Video & BNC input		-
DC Power	DC power input with 12V, 24V, 48V selection		

Environmental

Operation	0° to 50°C Degree
Storage	-5° to 60°C Degree
Relative Humidity	5~90%, non-condensing
Shock	10G acceleration (11ms duration)
Vibration	5~500Hz 1G RMS random vibration

3.2 Keyboard & Mouse

Chapter 3

For N-117 / 119 / 1417 / 1419 series

Supporting layouts

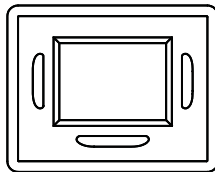
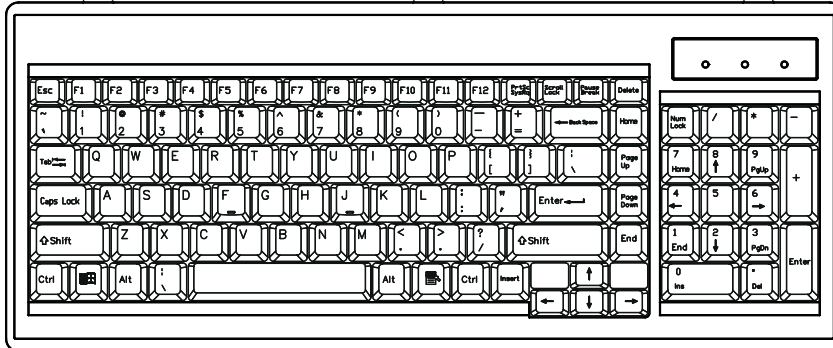

Ne N keyboard integrated with touchpad

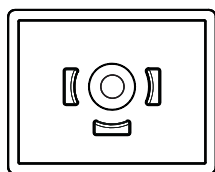
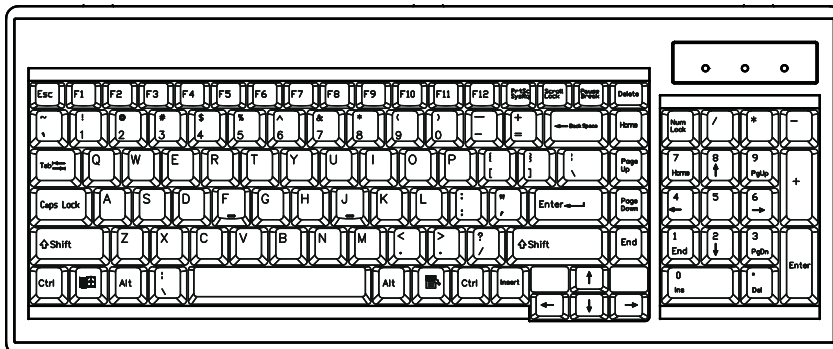

Nb N keyboard integrated with trackball

For NS-117 / 119 series

Supporting layouts



NSe

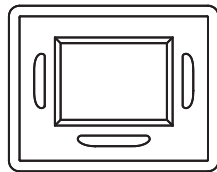
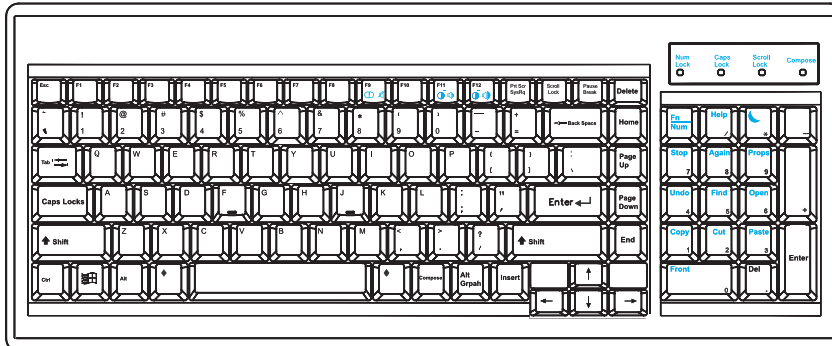

NS keyboard integrated with touchpad

- Incorporates SUN keys, including Stop, Cut, Paste, Compose, Copy and Help
- 104 key notepad keyboard with full numerical pad and SUN function
- USB interface

NSb

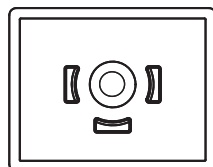
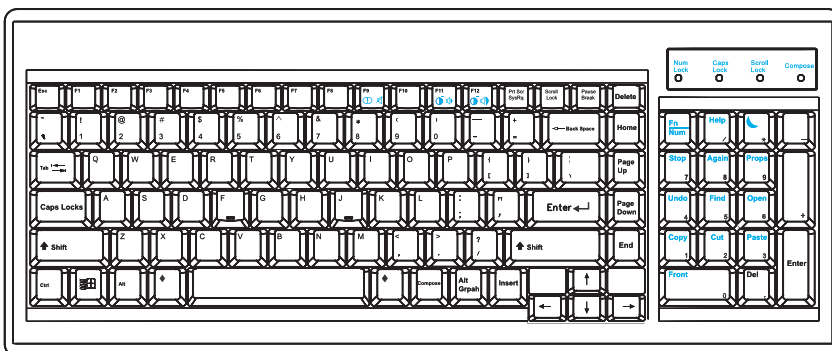

NS keyboard integrated with trackball

- Incorporates SUN keys, including Stop, Cut, Paste, Compose, Copy and Help
- 104 key notepad keyboard with full numerical pad and SUN function
- USB interface

- NS SUN-compatible keyboard incorporates SUN short-cut keys.

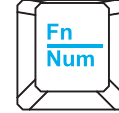
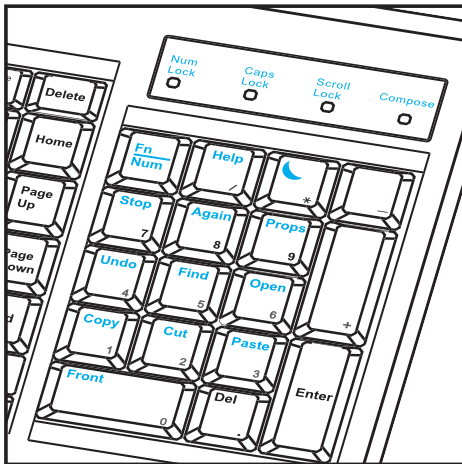

- Press the Fn/Num button to switch the color the Num LED.

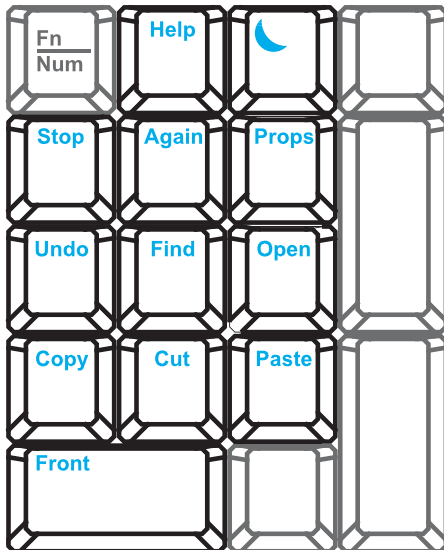

Num LED in Off mode

Key pad behaves as a SUN Solaris system administration command mode

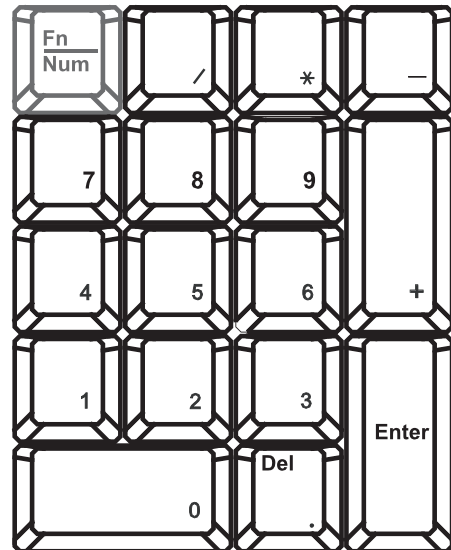

Num LED in Green color

Key pad behaves as a normal key pad mode

Three Audio / Display keys are located in the upper-right corner of the NS keyboard:

- Audio : Mute, decrease in volume and increase in volume.
- Display : Degauss, decrease contrast and increase contrast.
- Please ask your supplier for full details

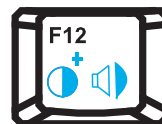
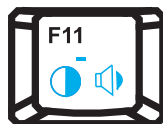
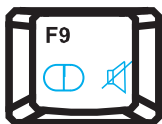

Our KVM is designed to seamlessly integrate into the rear of our full range of LCD drawer solutions:

- For KVM operation, please refer to KVM user manual
- Option with Multiple consoles Matrix KVM
- Option with high density & cost efficient Combo KVM integration with either 8 / 16 / 32 ports
- Option with low cost PS/2 KVM
- Please ask your supplier for full KVM details

Remarks

- NS series is for Matrix & Combo KVM only.

4.2 DVI-D Option

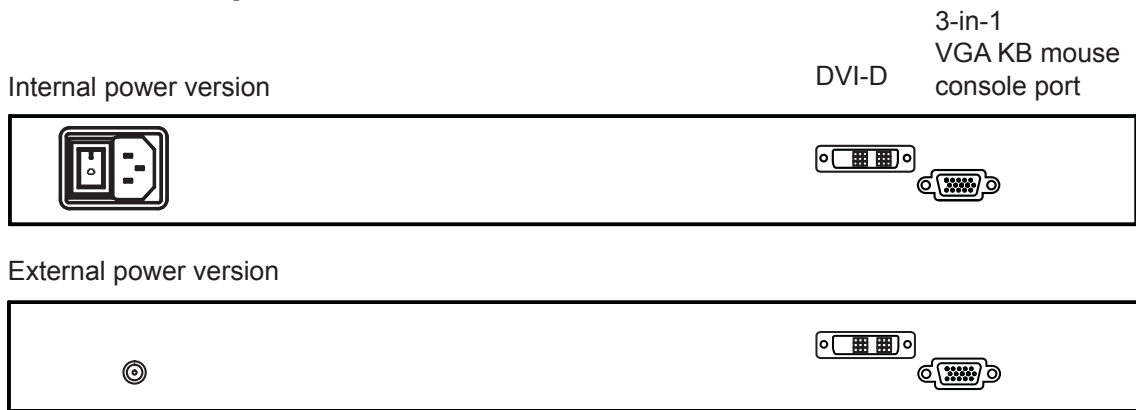

Remarks :

- Package includes 1 x 6ft DVI-D cable
- The depth of N-1417 / 1419 will be extended from 480mm (18.9") to 530mm (20.9")
- DVI-D is for N series only



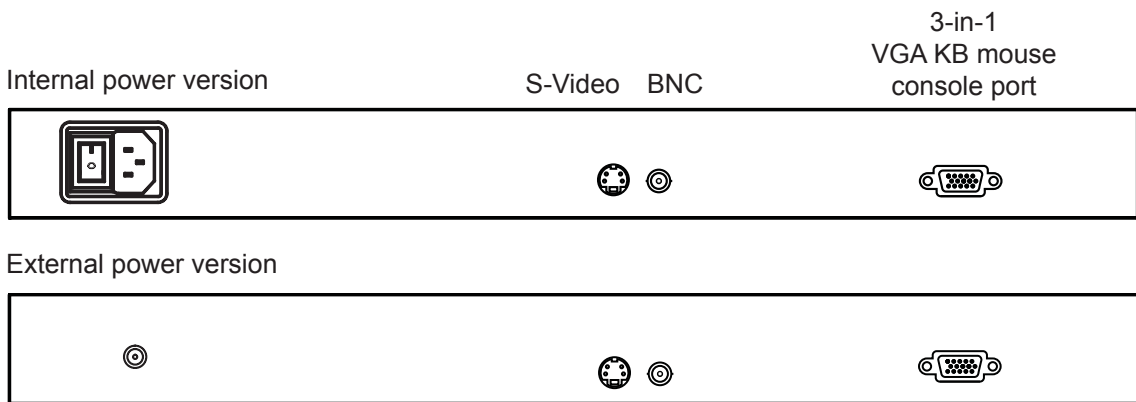



4.3 BNC + S-Video Option

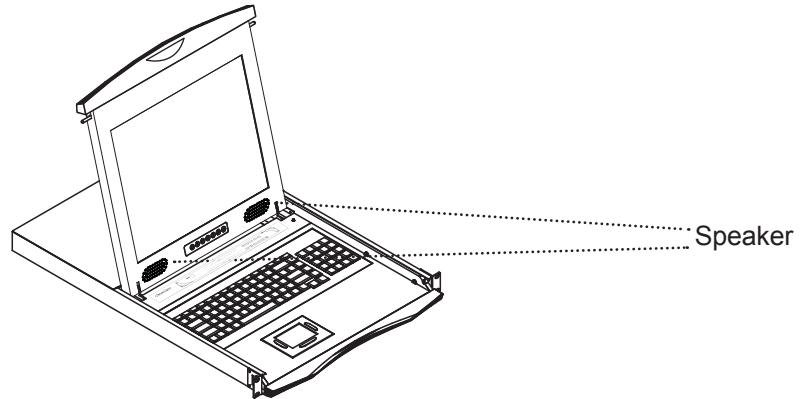

Remarks :

- Package includes 1 x 6ft S-Video cable
- BNC + S-Video Input is for N series only



	Power	Audio	3-in-1 VGA KB mouse console port
Internal power version			
External power version			

Remarks

- Audio input is 35mm audio plug
- The speaker is sharing the same power with LCD.

4.5 DC Power Options

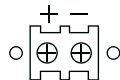

Model	12V	24V	48V
Input rating			
Input voltage:	12-Volt	24-Volt	48-Volt
Input range:	9 ~ 18V	18 ~ 36V	36 ~ 75V
Input current			
- No load	50 mA	50 mA	50 mA
- Full load	4950 mA	2450 mA	1220 mA
Output rating			
Output voltage:	12-Volt	12-Volt	12-Volt
Output current:	4.16A	4.16A	4.16A
Efficiency	84%	85%	85%

Remarks :

- Package does not include power cord and AC power adapter
- The depth of N-1417 / 1419 will be extended from 480mm (18.9") to 530mm (20.9")

1. Is interference signal appeared on LCD normal when shutting down the computer ?

In rare cases, interference may appear on the monitor. This may be caused by signal rate of VGA card and is considered normal. The image quality can be improved by adjusting the phase or pixel rate automatically or manually.

2. The membrane power light is not ON

Press the power On / Off on LCD membrane to check if the monitor is in the ON mode.

Check the power cord is properly connected to the LCD keyboard drawer and power outlet.

3. Screen image is not centered or sized properly

Press the  button for two seconds to automatically adjust the image.

Adjust the H-position and V-position settings via On-screen menu.

4. Is the LCD keyboard drawer hot-pluggable ?

The LCD keyboard drawer is hot-pluggable, but components of connected devices, such as the servers and KVMs, may not be hot-pluggable. We suggest turning off the power to all devices before connecting them. Apply power to connected devices again only after the LCD keyboard receives power.

For N-117 / 119 / 1417 / 1419 series

1. How do I adjust the resolution?

To change monitor resolution, click Start -> Control Panel -> Display. Select Setting tab to adjust the monitor resolution in Desktop Area. The available resolutions, "640 x 480", "800 x 600", "1024 x 768", "1152 x 864", "1280 x 1024", are determined by the display card in your computer.

For NS-117 / 119 series

1. How can I adjust the monitor resolution to 1152 x 900 for SUN Micro system ?

The NS solution LCD keyboard drawer will automatically detect the 1152 x 900 resolution, so no user configuration should be necessary.

2. How do I adjust the resolution in MS Windows operation system?

To change monitor resolution, click Start -> Control Panel -> Display. Select Setting tab to adjust the monitor resolution in Desktop Area. The available resolutions, "640 x 480", "800 x 600", "1024 x 768", "1152 x 864", "1280 x 1024", are determined by the display card in your computer.

3. The Stop-A hot key is not work in Trusted Solaris

The keyboard combination Stop-A (L1-A) is not available in Trusted Solaris by default. The security administrator can change this.

Model	Product Dimension (W x D x H)	Packing Dimension (W x D x H)	Net Weight	Gross Weight
N-117 series	442 x 650 x 44 mm 17.4 x 25.6 x 1.73"	589 x 856 x 168 mm 23.2 x 33.7 x 6.6"	16 kg 35 lb	22 kg 48 lb
N-119 series	442 x 650 x 44 mm 17.4 x 25.6 x 1.73"	589 x 856 x 168 mm 23.2 x 33.7 x 6.6"	17 kg 37 lb	23 kg 51 lb
NS-117 series	442 x 650 x 44 mm 17.4 x 25.6 x 1.73"	589 x 856 x 168 mm 23.2 x 33.7 x 6.6"	16 kg 35 lb	22 kg 48 lb
NS-119 series	442 x 650 x 44 mm 17.4 x 25.6 x 1.73"	589 x 856 x 168 mm 23.2 x 33.7 x 6.6"	17 kg 37 lb	23 kg 51 lb
N-1417 series	442 x 480 x 44 mm 17.4 x 18.9 x 1.73"	581 x 705 x 175 mm 22.9 x 27.8 x 6.9"	15 kg 33 lb	19 kg 42 lb
N-1419 series	442 x 480 x 44 mm 17.4 x 18.9 x 1.73"	581 x 705 x 175 mm 22.9 x 27.8 x 6.9"	16 kg 35 lb	20 kg 44 lb

The company reserves the right to modify product specifications without prior notice and assumes no responsibility for any error which may appear in this publication.

All brand names, logo and registered trademarks are properties of their respective owners.

Copyright 2010 Austin Hughes Electronics Ltd. All rights reserved.

CV-N6-1010V8