

User Manual 17" FHD 1080p LCD



**1080p
Full HD**

RKMTL-1U-17-DV

1U LCD Drawer

Options :

- SDI
- HDMI / Audio
- Touchscreen / DC power

Legal Information

First English printing, October 2002

Information in this document has been carefully checked for accuracy; however, no guarantee is given to the correctness of the contents. The information in this document is subject to change without notice. We are not liable for any injury or loss that results from the use of this equipment.

Safety Instructions

Please read all of these instructions carefully before you use the device. Save this manual for future reference.

- Unplug equipment before cleaning. Don't use liquid or spray detergent; use a moist cloth.
- Keep equipment away from excessive humidity and heat. Preferably, keep it in an air-conditioned environment with temperatures not exceeding 40° Celsius (104° Fahrenheit).
- When installing, place the equipment on a sturdy, level surface to prevent it from accidentally falling and causing damage to other equipment or injury to persons nearby.
- When the equipment is in an open position, do not cover, block or in any way obstruct the gap between it and the power supply. Proper air convection is necessary to keep it from overheating.
- Arrange the equipment's power cord in such a way that others won't trip or fall over it.
- If you are using a power cord that didn't ship with the equipment, ensure that it is rated for the voltage and current labeled on the equipment's electrical ratings label. The voltage rating on the cord should be higher than the one listed on the equipment's ratings label.
- Observe all precautions and warnings attached to the equipment.
- If you don't intend on using the equipment for a long time, disconnect it from the power outlet to prevent being damaged by transient over-voltage.
- Keep all liquids away from the equipment to minimize the risk of accidental spillage. Liquid spilled on to the power supply or on other hardware may cause damage, fire or electrical shock.
- Only qualified service personnel should open the chassis. Opening it yourself could damage the equipment and invalidate its warranty.
- If any part of the equipment becomes damaged or stops functioning, have it checked by qualified service personnel.

What the warranty does not cover

- Any product, on which the serial number has been defaced, modified or removed.
- Damage, deterioration or malfunction resulting from:
 - Accident, misuse, neglect, fire, water, lightning, or other acts of nature, unauthorized product modification, or failure to follow instructions supplied with the product.
 - Repair or attempted repair by anyone not authorized by us.
 - Any damage of the product due to shipment.
 - Removal or installation of the product.
 - Causes external to the product, such as electric power fluctuation or failure.
 - Use of supplies or parts not meeting our specifications.
 - Normal wear and tear.
 - Any other causes which does not relate to a product defect.
- Removal, installation, and set-up service charges.

Regulatory Notices Federal Communications Commission (FCC)

This equipment has been tested and found to comply with the limits for a Class B digital device, pursuant to Part 15 of the FCC rules. These limits are designed to provide reasonable protection against harmful interference in a residential installation.

Any changes or modifications made to this equipment may void the user's authority to operate this equipment. This equipment generates, uses, and can radiate radio frequency energy and, if not installed and used in accordance with the instructions, may cause harmful interference to radio communications.

However, there is no guarantee that interference will not occur in a particular installation. If this equipment does cause harmful interference to radio or television reception, which can be determined by turning the equipment off and on, the user is encouraged to try to correct the interference by one or more of the following measures:

- Re-position or relocate the receiving antenna.
- Increase the separation between the equipment and receiver.
- Connect the equipment into an outlet on a circuit different from that to which the receiver is connected.

Contents

< Part. 1 > RKMTL-1U-17-DV

1.1	Package Content	P.1
1.2	Structure Diagram & Dimension	P.1 - 2
1.3	Installation	P.3

< Part. 2 > Specifications / OSD

2.1	Product Specifications	P.4 - 5
2.2	On-screen Display Operation (OSD)	P.6 - 7
2.3	Picture In Picture (PIP) / Picture By Picture (PBP)	P.8 - 9

< Part. 3 > Options

3.1	3G / HD / SD- SDI Broadcast-grade input	P.10
3.2	HDMI & Audio	P.11
3.3	17" Touchscreen : Resistive	P.12
3.4	48V, 24V or 12VDC power	P.13

Before Installation

- It is very important to mount the equipment in a suitable cabinet or on a stable surface.
- Make sure the place has good ventilation, is out of direct sunlight, away from sources of excessive dust, dirt, heat, water, moisture and vibration.

Unpacking

The equipment comes with the standard parts shown in package content. Check and make sure they are included and in good condition. If anything is missing, or damaged, contact the supplier immediately.

How To Clean Your LCD Monitor



Caution :

- To avoid the risk of electric shock, make sure your hands are dry before unplugging your monitor from or plugging your monitor into an electrical outlet.
- When you clean your monitor, do not press down on the LCD screen. Pressing down on the screen can scratch or damage your display. Pressure damage is not covered under warranty.
- Use only cleansers made specifically for cleaning monitors and monitor screens. Cleansers not made to clean monitors and monitor screens can scratch the LCD display or strip off the finish.
- Do not spray any kind of liquid directly onto the screen or case of your monitor. Spraying liquids directly onto the screen or case can cause damage which is not covered under warranty.
- Do not use paper towels or abrasive pads to clean your monitor. Using an abrasive pad or any wood based paper product such as paper towels can scratch your LCD screen.

Cleaning Your Monitor

To clean your LCD safely, please follow these steps :

- 1 Disconnect the power cord.
- 2 Gently wipe the surface using a clean, dry microfiber cloth. Use as little pressure as possible.

Cleaning Tough Marks and Smudges

To remove tough marks and smudges, please follow these steps :

- 1 Disconnect the power cord.
- 2 Spray a small amount of non-abrasive cleanser on a microfiber cloth.

⚠ Caution : Do not spray or apply any liquids directly onto the monitor. Always apply the solution to your microfiber cloth first, not directly on the parts you are cleaning.

- 3 Gently wipe the surface. Use as little pressure as possible.
- 4 Wait until your monitor is completely dry before plugging it in and powering it up.

< Part 1 >

< 1.1 > Package Content



RKMTL-1U-17-DV unit X 1

- 6ft VGA cable X 1
- Power cord X 1
- M6 screw, cage nut & cup washer X 8



The above package content is only for the pure model (VGA and DVI-D only). It varies with options such as SDI, HDMI, audio, touchscreen & DC power.

< 1.2 > Structure Diagram

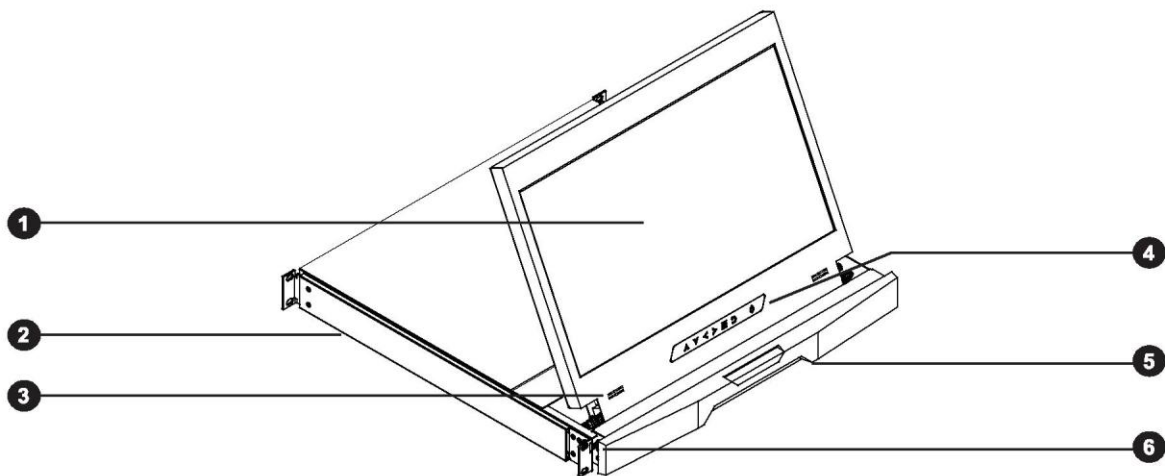

① LCD panel

② Installation Slide

③ Audio speaker (for HDMI or Audio option)

④ LCD OSD membrane

⑤ Carry handle to release the 2-pt lock

⑥ 2-point lock



< 1.2 > Dimension

RKMTL-1U-17-DV

Front View

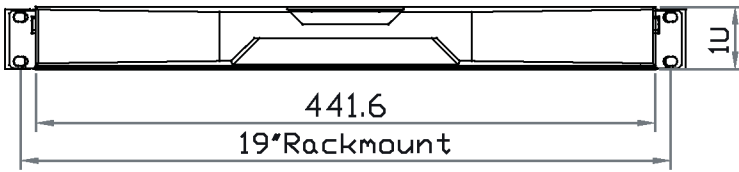

Side View

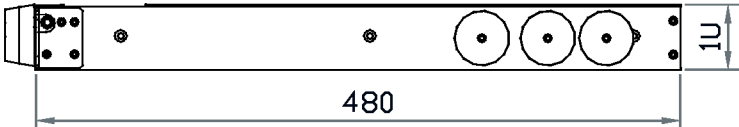

UNIT : mm
1mm = 0.03937 inch

Top View



Model	Product Dimension (W x D x H)	Packing Dimension (W x D x H)	Net Weight	Gross Weight
RKMTL-1U-17-DV	441.6 x 480 x 44 mm 17.4 x 18.1 x 1.73"	590 x 687 x 120 mm 23.2 x 27 x 4.7"	11 kg 24 lb	15 kg 33 lb

 The weight is only for the pure models. It varies with accessories & options such as SDI, HDMI, audio, touchscreen & DC power.

< 1.3 > Installation - How to install Installation Slides

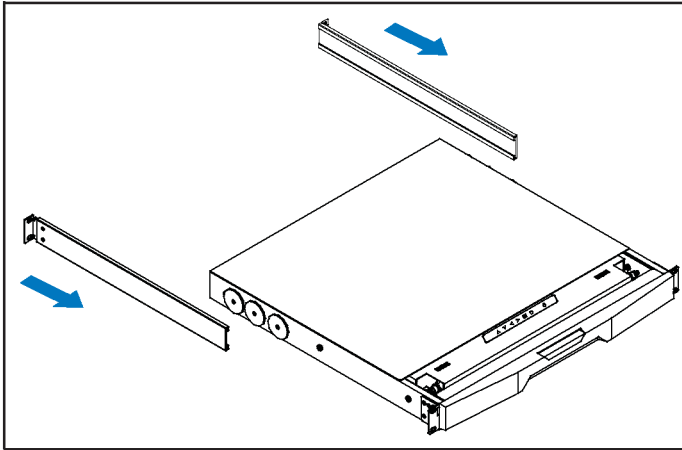

Step 1

- Insert the left and right rear mounting brackets into the display drawer.

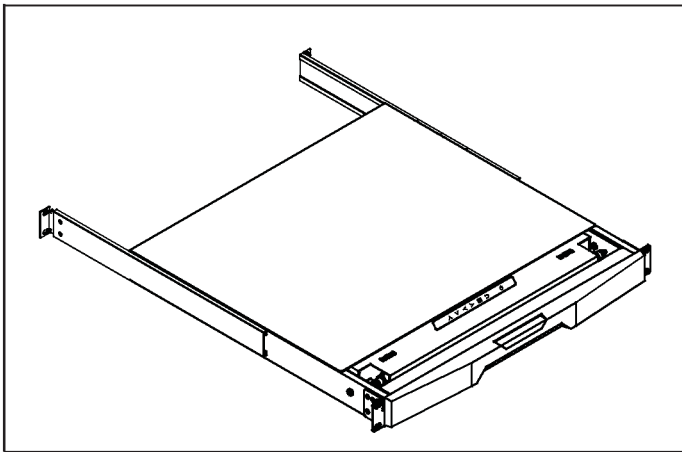

Step 2

- Measure the depth of the front and rear mounting rails.
- Align each rear mounting bracket to a suitable length.

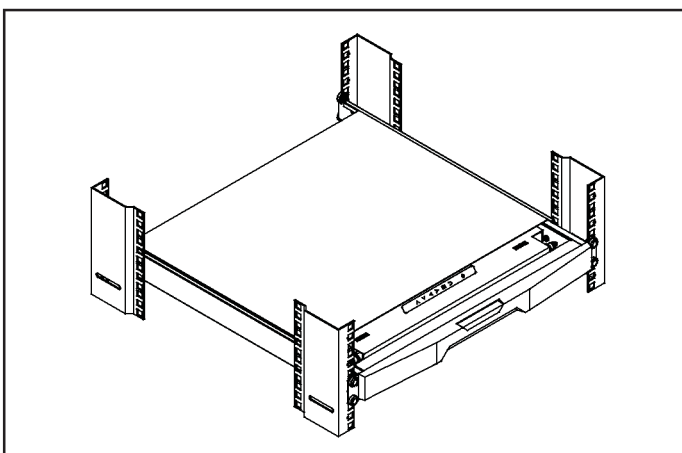

Step 3

Complete the installation

- Fix the display drawer into the rack.

 **M6 screw, cage nut & cup washer x 8 are provided.**

< Part 2 >

< 2.1 > Product Specifications

RKMTL-1U-17-DV

LCD	Panel Size (diagonal)	17.3-inch Widescreen TFT color LCD
Panel	Display pixel (dots x lines)	1920 x 1080
	Brightness (typ.)	300
	Contrast Ratio (typ.)	600:1
	Color	1.07 Billion, 10-bit
	Viewing Angle (L/R/U/D)	89/89/89/89
	Response Time (ms)	35
	Dot pitch (mm)	0.199
	Display Area (mm)	381.9H x 214.8V
	Surface treatment	Anti-glare, Hard-coating
	Surface hardness	3H
	Backlight Type	LED
	MTBF (hrs)	20,000

Video Connectivity	Digital	HDMI	HDMI 1.1, CEA-861-D
		DVI	DVI-D, TMDS single link
	Analog	VGA	Analog 0.7Vp-p
	Plug & Play	DVI / VGA	VESA EDID structure 1.3
	Synchronization	VGA	Separate, Composite & SOG

Audio Connectivity	Audio Input	Connector	3.5mm stereo jack
		Impedance / Power level	30Ω/ 750mV
	Audio Output	Connector	3.5mm stereo jack
		Resistance / Power level	30Ω / 2.8V
	Speaker Output	Power	2 x 2W

*When the audio output is connected, speaker output is OFF

Power	Power Supply	Range	Auto-sensing 100 to 240VAC, 50 / 60Hz
	Power Consumption	Screen display ON	34W or less
Power saving mode		4W or less	
Power button OFF		1W or less	





Regulatory	Safety Approval	FCC & CE
-------------------	-----------------	----------

Environmental Conditions	Operating	Temperature	0 to 50°C degree
		Humidity	20~90%, non-condensing
	Storage	Temperature	-5 to 60°C degree
		Humidity	5~90%, non-condensing
		Shock	10G acceleration (11ms duration)
		Vibration	5~500Hz 1G RMS random

Physical Specification	Product (W x D x H)	441.6 x 480 x 44 mm 17.4 x 18.9 x 1.73 inch
	Packing (W x D x H)	590 x 687 x 120 mm 23.2 x 27 x 4.7 inch
	Net Weight	11 kgs / 24 lbs
	Gross Weight	15 kgs / 33 lbs

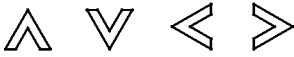

Applicable Format	DVI-D / VGA Input	PC Signal	1920 x 1080 x 60Hz
			1280 x 1024 x 60 / 75Hz 1280 x 960 x 60Hz 1280 x 768 x 60 / 75Hz 1152 x 864 x 75Hz 1024 x 768 x 60 / 70 / 75Hz 848 x 480 x 60Hz 800 x 600 x 60 / 72 / 75Hz 720 x 400 x 70Hz 640 x 480 x 60 / 72 / 75Hz 640 x 400 x 70Hz 640 x 350 x 70Hz



Membrane Switch	Function
	Turn the monitor on or off
	Display the OSD menu Act as an Enter key to select screen setting options
	Scroll through menu options and adjust the displayed control
	Exit the OSD screen Go back to the previous on-screen sub-menu or main menu

Remark : All LED touch buttons in **WHITE** light.

The LED of **Power**  touch button will flash continuously when there is no signal input.

- ① All the LED touch buttons will automatically turn off after 10 minutes of idle status (except the **Power** ).
- ② Light up all membrane buttons, please press any button for 1 - 2 seconds (except the **Power** ).

1 Picture

- Picture mode : Standard / Vivid / Soft / User mode to choose
- Brightness : Adjust background black level of the screen image
- Contrast : Adjust the difference between the image background (black level) and the foreground (white level)
- Hue: Adjust the screen hue value
- Saturation : Adjust the saturation of the image color
- Picture size : Adjust the image size
- Color temp : Standard / Cool / Warm / User to choose
- Noise reduce : Reduce the noise of the image
- Sharpness : Adjust the image from weak to sharp

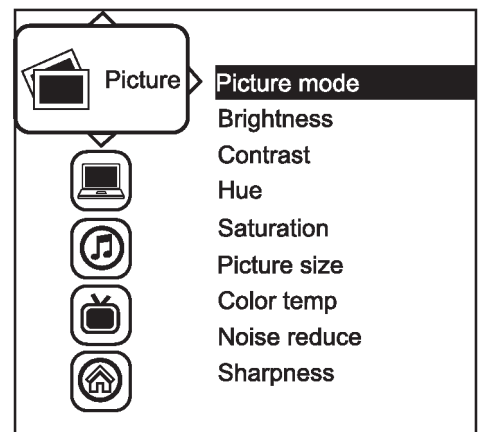

< 2.2 > On-screen Display Operation (OSD)

2 PC

Auto adjust :	Automatically adjust sizes, centers and Fine tunes the video signal to eliminate waviness and distortion.
Clock :	Adjust the clock value
Phase :	Adjust the phase value
H. Position :	Align the screen image left or right
V. Position :	Align the screen image up or down

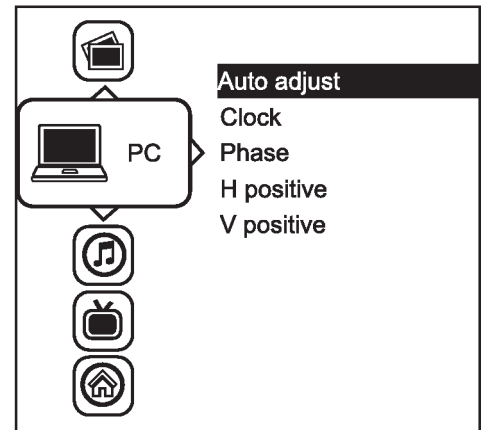

3 Audio

Audio mode :	Movie / Voice / Normal / Music mode to choose
Volume :	Adjust the volume of sound
Bass :	Set the value of bass sound
Treble :	Set the value of treble sound
Balance :	Set the balance value of treble and bass sound
Analog TV audio :	Set the value of analog TV audio sound
Mute :	Turn off the surrounding sound

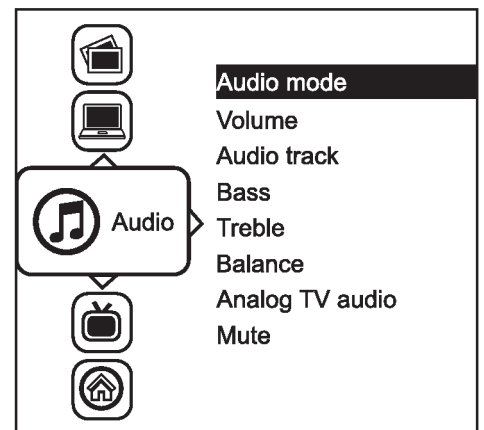

4 MISC

Language :	Select the language in which the OSD menu is displayed - English
Sleep timer :	Set the off time
PIP mode :	Adjust picture in picture setting
PIP position :	Enter into PIP position
PIP source :	Enter into the Sub source and sound source
System reset :	Return the adjustment back to factory setting
Information :	Select for Help

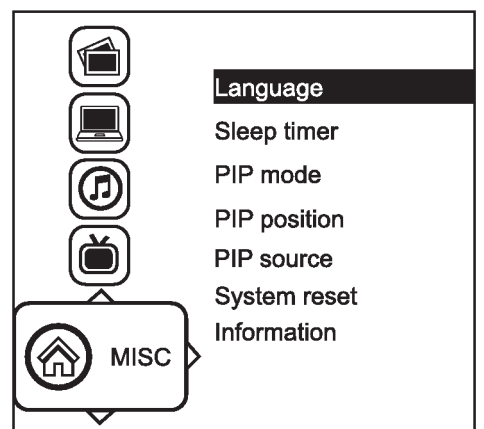

< 2.3 > How to Use Picture In Picture (PIP) / Picture By Picture (PBP) RKMTL-1U-17-DV

< 2.3.1 > Picture in Picture (PIP)

Mode

Display the Sub screen in the Main screen.

OSD Menu → MISC → PIP Mode → Large / Small / OFF

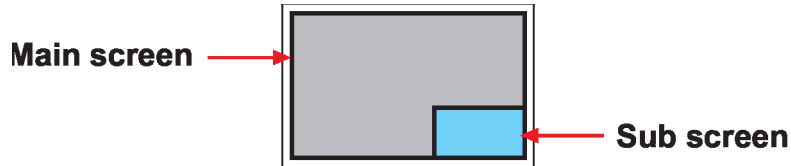

Position

Adjust the position of the Sub screen (top left, bottom left, top right, bottom right)

OSD Menu → MISC → PIP Position → top left / top right / bottom left / bottom right

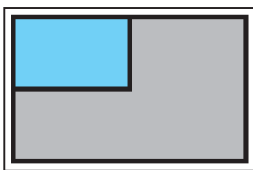

top left

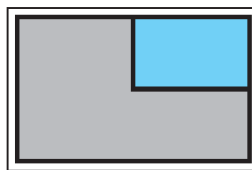

top right

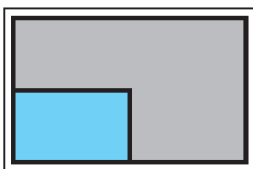

bottom left

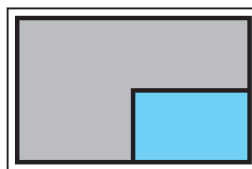

bottom right

Size

Adjust the size of the Sub screen (Large / Small) OSD

Menu → MISC → PIP Mode → Large / Small

Size of Sub screen

LCD Monitor	Large Sub screen	Small Sub screen
1920 x 1200	552 x 414	480 x 360
1920 x 1080	552 x 414	480 x 360
1440 x 900	414 x 310	360 x 270
1366 x 768	392 x 294	340 x 254
1280 x 1024	368 x 276	320 x 240

< 2.3.2 > Picture By Picture (PBP)

Mode

Display the Sub screen next to the Main screen.

OSD Menu → MISC → PIP Mode → PBP



Size

LCD Monitor	Main / Sub screen
1920 x 1200	955 x 716
1920 x 1080	955 x 716
1440 x 900	715 x 536
1366 x 768	678 x 508
1280 x 1024	635 x 476

< 2.3.3 > PIP / PBP Source

To select an input signal for PIP / PBP Sub screen.

OSD Menu → MISC → PIP Source → VGA / S-Video / Composite / DVI / HDMI / SDI / YPbPr / TV

The PIP / PBP is operable in the following table :

Main	Sub	VGA	S-Video	Composite	DVI-D	HDMI	SDI	YPbPr	TV
VGA		X	O	O	O	O	O	O	O
S-Video		O	X	X	O	O	O	O	X
Composite		O	X	X	O	O	O	O	X
DVI		O	O	O	X	X	O	O	O
HDMI		O	O	O	X	X	O	O	O
SDI		O	O	O	O	O	X	X	O
YPbPr		O	O	O	O	O	X	X	O
TV		O	X	X	O	O	O	O	X

< Part 3 >

< 3.1 > Options : 3G / HD / SD-SDI input

RKMTL-1U-17-DV



KVMSwitchTech's SDI input is an ideal solution for the broadcast-grade video and high resolution CCTV market.

Designed for use with Full HD 1080p and ultra high resolution 1920 x 1200 LCD displays, Austin Hughes provides a SDI input module without using additional space or power and it comes standard with a 2-year warranty.

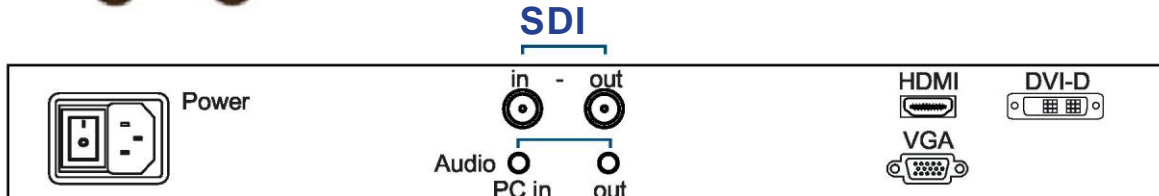

For SDI option, casing depth will be extended from 480mm (18.9") to 530mm (20.9")

INPUT	3G-SDI IN	BNC x 1 / 0.8Vp-p (75 ohm)
	3G-SDI OUT	BNC x 1 / Active through, equalized & relocked

Standard Compliance	Video	SMPTE 425M / 274M / 296M / 125M ITU-R BT.656
	Audio	SMPTE 299M / 272M-C

Compatible Video Format	3G-SDI	1080p	@60 / 50Hz, 4:2:2
		1080p	@30 / 25 / 24Hz, 4:4:4
		1080i	@60 / 50Hz, 4:4:4
		720p	@60 / 50Hz, 4:4:4
	HD-SDI	1080p	@30 / 25 / 24Hz, 4:2:2
		1080i	@60 / 50Hz, 4:2:2
		720p	@60 / 50Hz, 4:2:2
	SD-SDI	480i	@60Hz, 4:2:2
ITU-R BT.656		576i	@50Hz, 4:2:2

Compatible Audio Format	3G-SDI	48kHz, 16 / 20 / 24 bit, 2 CH, Synchronized Video
	HD-SDI	48kHz, 16 / 20 / 24 bit, 2 CH, Synchronized Video
	SD-SDI	48kHz, 16 / 20 / 24 bit, 2 CH, Synchronized / Asynchronized Video

Max. Transmission Distance 75 ohm coaxial cable	3G-SDI	150m at 2.97Gb/s
	HD-SDI	250m at 1.485Gb/s
	SD-SDI	480m at 270Mb/s

< 3.2 > Options :

- **HDMI** (HDMI 1.1, CEA-861-D)
- **Audio** (3.5mm audio jacks for audio in & out, and 2W + 2W speakers)



For the above options, casing depth will be extended from 480mm (18.9") to 530mm (20.9")

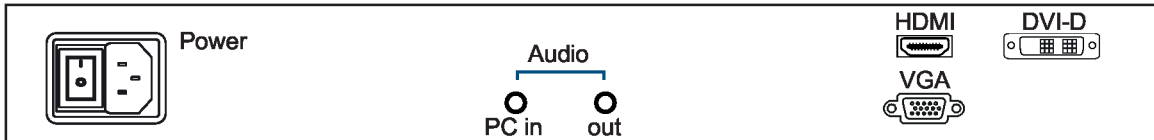



F17" USB Touchscreen Specification

Model	R	R
Technology	5-Wire Resistive	
Touch Point	Single	
Method	Stylus or Finger	
Activation Force	≤ 50g / Stylus=R0.8	
Durability	10 million touches	
Response Time	15 ms	
Optical Transmittance	80% ± 3%	
Surface Hardness	3H	
Haze	8% ± 3%	
Glass	2.2 ±0.2 mm	
Connector	USB Type A	
Compatibility	Windows 7 / XP / Vista, Linux	

- USB touchscreen package includes 1 x 6ft USB cable, quick reference guideline and CD disc
- For detailed information, please refer to the attached CD disc
- As the touchscreen unit is not made of toughened glass please handle it carefully

USB Touchscreen



For touchscreen option, casing depth will be extended from 480mm (18.9") to 530mm (20.9")

Please follow the below steps to setup the touch screen:-

- Step 1.** Run the bundled CD disc or download the driver from the link below : <http://www.austin-hughes.com/downloads/RMDL/software.html>
- Step 2.** Double click the Setup.exe
- Step 3.** Follow the installation instruction to finish the setup
- Step 4.** After installation, run the TouchKit program & the "4 point calibration"

 Please do the initial calibration after the first setup



< 3.4 > Options : DC Power

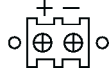

Model	12V	24V	48V
Input rating			
Input voltage:	12-Volt	24-Volt	48-Volt
Input range:	9 — 18V	18 — 36V	36 — 75V
Input current			
- No load	50 mA	50 mA	50 mA
- Full load	4950 mA	2450 mA	1220 mA
Output rating			
Output voltage:	12-Volt	12-Volt	12-Volt
Output current:	4.16A	4.16A	4.16A
Efficiency	84%	85%	85%

DC power

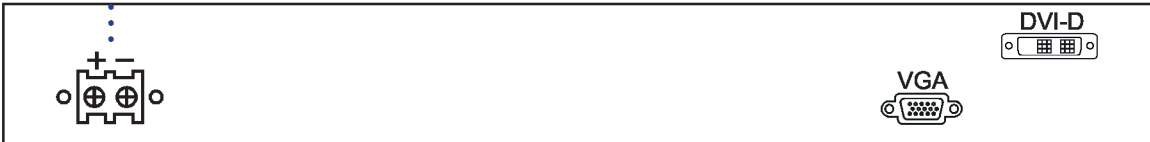

For DC power option :

(1) Option excludes 1 x power cord and 1 x AC power adapter.

(2) Casing depth will be extended from 480mm (18.9") to 530mm (20.9")

The company reserves the right to modify product specifications without prior notice and assumes no responsibility for any error which may appear in this publication.

All brand names, logo and registered trademarks are properties of their respective owners.