

Instruction Manual



MODEL : AB-4148
4x8 VGA-AUDIO MATRIX SWITCHER

4x8 VGA-AUDIO Matrix Switcher Series

Thank you for purchasing the AB-4148 VGA-AUDIO Matrix Switcher. You will find this unit easy to install and highly reliable but it is essential that you read this manual thoroughly before attempting to use 4x8 VGA-Audio Matrix Switcher.

SAFETY INFORMATION

1. Save the carton and packing material even if the equipment has arrived in good condition. Should you ever need to ship the unit, use only the original factory packing.
2. Read all documentation before operating your equipment. Retain all documentation for future reference.
3. Follow all instructions printed on unit chassis for proper operation.
4. Do not spill water or other liquids into or on the unit, or operate the unit while standing in liquid.
5. Make sure power outlets conform to the power requirements listed on the back of the unit.
6. Do not use the unit if the electrical power cord is frayed or broken. The power supply cords should be routed so that they are not likely to be walked on or pinched by items placed upon or against them, paying particular attention to cords and plugs, convenience receptacles, and the point where they exit from the appliance.
7. Always operate the unit with the AC ground wire connected to the electrical system ground. Precautions should be taken so that the means of grounding of a piece of equipment is not defeated.
8. Mains voltage must be correct and the same as that printed on the rear of the unit. Damage caused by connection to improper AC voltage is not covered by any warranty.
9. Power down & disconnect unit from mains voltage before making connections.
10. Never hold a power switch in the "ON" position.
11. Do not use the unit near stoves, heat registers, radiators, or other heat Producing devices.
12. Do not block fan intake or exhaust ports. Do not operate equipment on a surface or in an environment which may impede the normal flow of air around the unit, such as a bed, rug, carpet, or completely enclosed rack. If the unit is used in an extremely dusty or smoky environment, the unit should be Periodically "blown free" of foreign matter.
13. Do not remove the cover. Removing the cover will expose you to potentially dangerous voltages. There are no user serviceable parts inside.
14. Do not drive the inputs with a signal level greater than that required to drive equipment to full output.
15. Non-use periods. The power cord of equipment should be unplugged from the outlet when left unused for a long period of time.
16. Service Information Equipment should be serviced by qualifier service personnel when:
 - A. The power supply cord or the plug has been damaged.
 - B. Objects have fallen, or liquid has been spilled into the equipment.
 - C. The equipment has been exposed to rain
 - D. The equipment does not appear to operate normally, or exhibits a marked change in performance
 - E. The equipment has been dropped, or the enclosure damaged.

IMPORTANT SAFETY INSTRUCTIONS

To insure the best from this product, please read this manual carefully. Keep it in a safe place for future reference.

To reduce the risk of electric shock, do not remove the cover from the unit. No user serviceable parts inside. Refer servicing to qualified personnel.

To reduce the risk of fire, do not expose the unit to rain, water or excessive moisture.

Do not force switched or external connections.

When moving the unit disconnect the serial port connections first then the power cable and finally the interconnecting cables to other devices.

Do not attempt to clean the unit with chemical solvents or aerosol cleaners, as this may damage the unit. Use a clean dry cloth.

Installation of this unit should be in a cool dry place, away from sources of excessive heat, vibration, dust, moisture and cold.

TABLE OF CONTENTS & INTRODUCTION

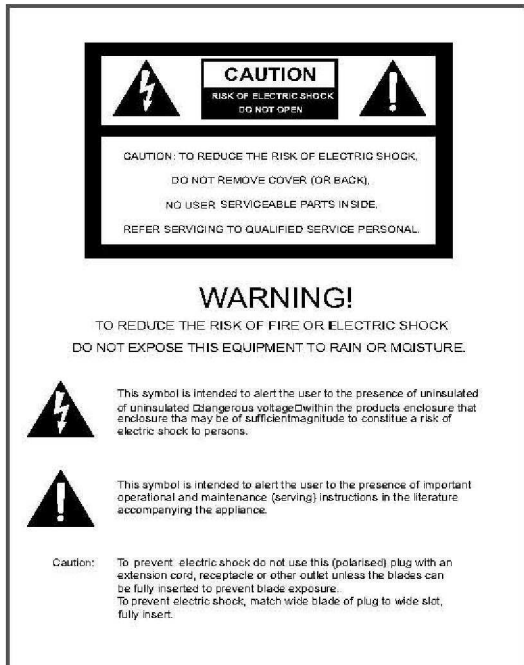

TABLE OF CONTENTS & INTRODUCTION	3
FRONT PANEL	4
REAR PANEL	5
REMOTE CONTROL	6
FEATURES & SPECIFICATIONS	7
RS232 SERIAL INTERFACE	8
RS232 PROTOCOL COMMANDS	9
TYPICAL APPLICATION	10
LIMITED WARRANTY	11

INSTRUCTION

Congratulations on your purchase of one of the most innovative VGA(RGBHV)/StereoAudio(AR/AL) 4x8 matrix switching products on the market today.

The **AB-4148** is a true Matrix Routing Switcher for VGA(RGBHV)/StereoAudio(AR/AL) signals.

It has 4 individual VGA(RGBHV)/StereoAudio(AR/AL) inputs with 8 individual RGBHV/Audio outputs.

Because it is a matrix router, any input may be routed to any output; or the same input may be routed to all outputs or any combination. It completely eliminates the need to constantly move around audio and video input output cables.

The **AB-4148** is useful for Matrix signals from VGA source devices (such as: Personal computer, Set Top Box, and Satellite Receivers, etc.) To VGA destination devices (Such as LCD Monitors, VGA Monitors, Plasma LCD TV, VGA Projectors, etc.). Selection of inputs is made via the front panel push buttons or an Infrared Remote Control unit or RS 232 control by a computer.

PACKAGE CONTENTS

Before attempting to use this unit, please check the packaging and make certain the following items are contained in the shipping carton :

1. Main console unit
2. Operating Instructions
3. IR Remote Controller (**SW-4148**)
4. 19 inch 1RU(13/4") rack mount brackets
5. RS232 DRV package
6. Power Supply 12VDC, Universal Type 50160Hz, 100-230 VAC

Note :

Please retain the original packing material should the need ever arise to return the unit.

If you find any items are missing, contact your reseller immediately.

Have the Model Number, Serial Number and Invoice available for reference when you call.

FRONT PANEL

FRONT PANEL

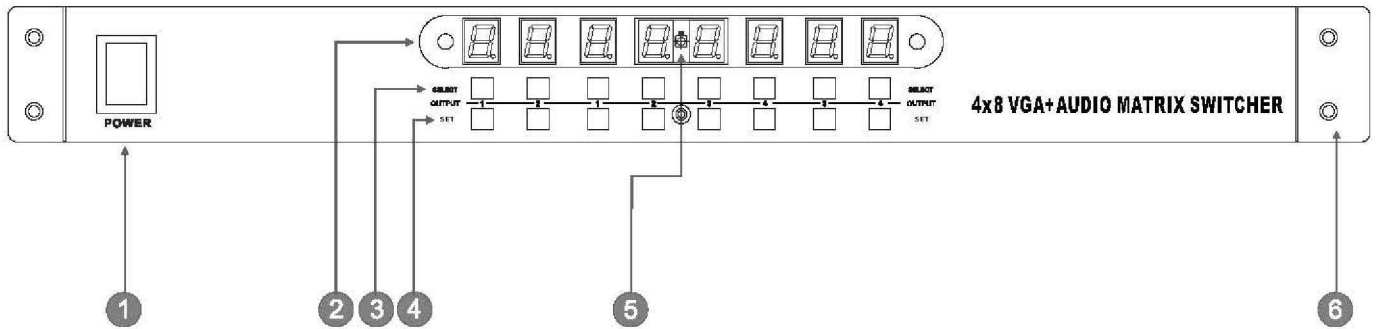

1 POWER ON SWITCH

The power switch turns the unit on and off.
The LED will illuminate red to indicate that the switcher is ON and is receiving power

2 SOURCE DEVICE STATUS LED DISPLAY

Channels 1 to 4 shown from LED display illuminates red to indicate that a video source is present on that input.

3 SOURCE DEVICE SELECT BUTTONS

A separate output 1 thru 8 source select buttons are provided for each destination.

4 SOURCE SET BUTTONS

Setup the input sources 1 thru 4 channel

5 IR SENSOR

The IR sensor receives IR commands from the supplied remote controller.

6 19 INCH EAR MOUNT PAIR

19 inch 1RU(1 $\frac{3}{4}$ ") rack mount brackets
Part number : 1U-440L

De-press "Select" button until the desired Output channel appears. Then immediately depress the "Set" button to lock in that channel.

For example:

To select input source #2 to destination output #1, you would depress the "Select" button in the first channel until the display changes to " 2." Then immediately depress the "Set" button.

OPERATING THE UNIT

Once you have connected the switcher as described above, you must be certain that the input are being fed appropriate signals and are not suffering from signal loss due to cabling problems or problems with the source device.

If the input signals to the switcher are appropriate, switch the power switch to <ON> and you should see and hear the signals on the devices you have connected to the various output connectors of the switcher.

POWER AND CONNECTIONS

This unit is not disconnected from the AC power source as long as it is connected to the wall outlet. The off state for this unit is called standby mode. In standby mode the unit is designed to consume a reduced quantity of power compared to normal operating modes.

When not using the unit for a long period of time. Insure that the AC power cord is disconnected from the wall outlet.

The AC wall outlet should be installed near to the unit and be easily accessible.

Do not plug in or attempt to operate an obviously damaged unit.

REAR PANEL

REAR PANEL

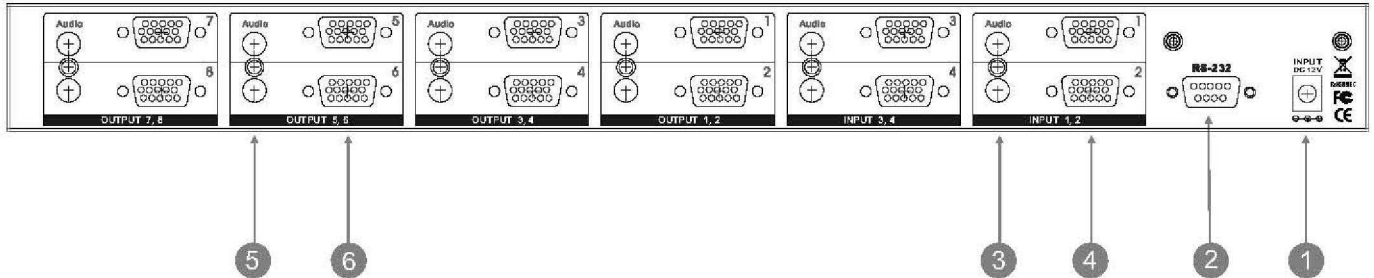

1 DC POWER INLET

The switcher is fitted with a DC power plug input connector. Please ensure that the plug used is of an approved type and is of sufficient current carrying capacity with the correct voltage and connector polarity. 12Volt DC power supply 1A~2A Max.



Power Jack:
DC Jack - inner OD ϕ 2.1mm (+)
Outside OD ϕ 5.5mm (GND)
Power input - 12VDC, 1A~2A
Switcher power supplier use universal
Part number : TA 007

2 RS 232 CONNECTION

RS 232 control port to allow for interfacing to a PC. Such as a computer or touch panel control, to the switcher via this DB-9pin Female connector for serial RS-232 control.



Remote port :
DB-9pin Female connector

3 INPUTS : 1~4 AUDIO DEVICE SOURCES

Connect a Stereo Audio signal from 4x source devices and output to 8x Stereo Audio speakers or devices



Stereo Audio(AR/AL) Via 1x ϕ 3.5mm ear phone jack connector

Note:
With 1x female phone jack each channel

4 INPUTS : 1~4 VGA DEVICE SOURCES

Connect a VGA (RGBHV) signal via 4x source of devices and output to 8x VGA Monitors or displays

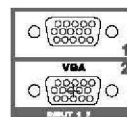

VGA (RGBHV) Via 1x HD-15p connector

Note:
With 1x female D-Sub connector.

5 OUTPUTS: 1~8 AUDIO DESTINATION

Connect 4x Stereo Audio signal to 8x speakers or devices via 2xRCA Audio Cables.



Stereo Audio(AR/AL) Via 1x ϕ 3.5mm ear phone jack connector

Note:
With 1x female phone jack each channel

6 OUTPUTS : 1~8 VGA-RGBHV DESTINATION

Connect 4x VGA signal to 8x VGA Monitors or displays via HD15P D-sub VGA cables.

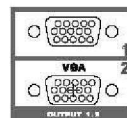

VGA (RGBHV) Via 1x HD-15p connector

Note:
With 1x female D-Sub connector.

REMOTE CONTROL

Before making any connections to the **AB-4148**. Observe the following:

- > Ensure the mains voltage supply matches the label on the supplied plug-Pack (+/- 10%)
- > Ensure that the power switch is OFF
- > Ensure that all system grounds (earth) are connected to a common point.
- > Avoid powering equipment within a system from multiple power sources that may be separated by large distance
- > Connect all audio video sources and destination equipment
- > power up all source and destination audio-visual sources
- > For each destination output select the appropriate Input source by using The front panel input 1~8 select buttons. The supplied IR remote control. Or through the RS 232 serial communications port.
- > Upon power up the switcher will return to its last used setting before Powered down.

REMOTE CONTROL

- 1 2** SWITCH POWER ON or OFF
Controller with a separate power ON and OFF

- 3** OUTPUTS : SELECTION 1~8 DESTINATION
- Output - 1 : Switch 4x VGA sources to # 1 Destination-Monitor
 - Output - 2 : Switch 4x VGA sources to # 2 Destination-Monitor
 - Output - 3 : Switch 4x VGA sources to # 3 Destination-Monitor
 - Output - 4 : Switch 4x VGA sources to # 4 Destination-Monitor
 - Output - 5 : Switch 4x VGA sources to # 5 Destination-Monitor
 - Output - 6 : Switch 4x VGA sources to # 6 Destination-Monitor
 - Output - 7 : Switch 4x VGA sources to # 7 Destination-Monitor
 - Output - 8 : Switch 4x VGA sources to # 8 Destination-Monitor

- 4** INPUTS : SELECTION 1~ 4 SOURCES
- Input - Source 1 : VGA+Audio Signal source device # 1
 - Input - Source 2 : VGA+Audio Signal source device # 2
 - Input - Source 3 : VGA+Audio Signal source device # 3
 - Input - Source 4 : VGA+Audio Signal source device # 4

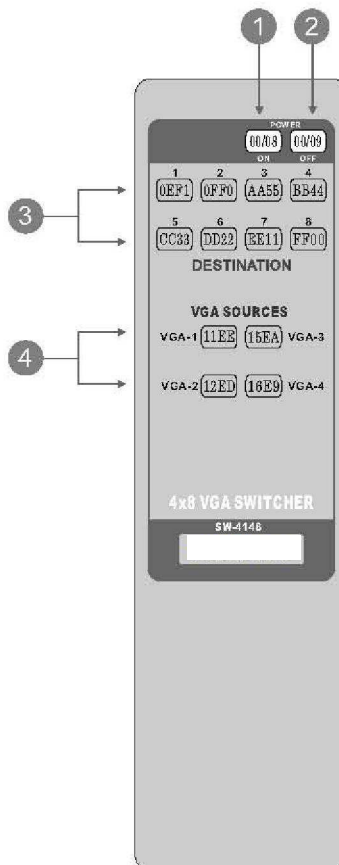

HOW TO SETUP IR CODES :

IR Type : uPD6121G
POWER ON : 00FF 08F7
POWER OFF : 00FF 09F6

OUTPUT#1 / INPUT#1	: 0EF1 11EE
OUTPUT#1 / INPUT#2	: 0EF1 12ED
OUTPUT#1 / INPUT#3	: 0EF1 15EA
OUTPUT#1 / INPUT#4	: 0EF1 16E9
OUTPUT#2 / INPUT#1	: 0FF0 11EE
OUTPUT#2 / INPUT#2	: 0FF0 12ED
OUTPUT#2 / INPUT#3	: 0FF0 15EA
OUTPUT#2 / INPUT#4	: 0FF0 16E9
OUTPUT#3 / INPUT#1	: AA55 11EE
OUTPUT#3 / INPUT#2	: AA55 12ED
OUTPUT#3 / INPUT#3	: AA55 15EA
OUTPUT#3 / INPUT#4	: AA55 16E9
OUTPUT#4 / INPUT#1	: BB44 11EE
OUTPUT#4 / INPUT#2	: BB44 12ED
OUTPUT#4 / INPUT#3	: BB44 15EA
OUTPUT#4 / INPUT#4	: BB44 16E9
OUTPUT#5 / INPUT#1	: CC33 11EE
OUTPUT#5 / INPUT#2	: CC33 12ED
OUTPUT#5 / INPUT#3	: CC33 15EA
OUTPUT#5 / INPUT#4	: CC33 16E9
OUTPUT#6 / INPUT#1	: DD22 11EE
OUTPUT#6 / INPUT#2	: DD22 12ED
OUTPUT#6 / INPUT#3	: DD22 15EA
OUTPUT#6 / INPUT#4	: DD22 16E9
OUTPUT#7 / INPUT#1	: EE11 11EE
OUTPUT#7 / INPUT#2	: EE11 12ED
OUTPUT#7 / INPUT#3	: EE11 15EA
OUTPUT#7 / INPUT#4	: EE11 16E9
OUTPUT#8 / INPUT#1	: FF00 11EE
OUTPUT#8 / INPUT#2	: FF00 12ED
OUTPUT#8 / INPUT#3	: FF00 15EA
OUTPUT#8 / INPUT#4	: FF00 16E9

CONNECTING THE HARDWARE

Please study the panel drawings below and become familiar with the signal input-output, Power requirements plus any controls present.

Before using the switcher, please take the time to make certain that the device you wish to connect to its inputs is functioning properly in all respects. Verify that the video and audio signals are present and are being displayed properly on a suitable device.

If all is well connect the appropriate cables between the output of the device you wish to distribute to output(s) of the switcher to the various devices you wish to feed a signal to. Lastly, connect the AC to DC adaptor, connect the DC connector to the switcher first and then plug the adaptor into a functional AC outlet.

FEATURES & SPECIFICATIONS

FEATURES

1. Supports 4x inputs VGA+Audio to 8x VGA-Audio outputs Matrix Switcher
2. Input signal type VGA (RGBHV), Stereo Audio(AR/AL)
3. Output Signal type VGA and Stereo Audio to VGA Monitor display
3. Higher Video Bandwidth 325MHz each path R,G,B signals.
4. Supported HD high definition resolutions XGA, SXGA, UXGA, WSXGA, WUXGA
5. RS232 Serial interface via Ethernet control is optional
6. Compatible with all VGA Video Monitor devices, Plasma display and Projectors
7. Supported RS232 serial interface protocol commands list
8. Control PC RS232 Drive compatible with win-95/98/2000/xp
9. Various User Interface controls:
 - Attached Window based control software for Desktop or NB control by RS232 port
 - Manual controlled by Front Panel button
 - IR remote control
10. Support desktop with Ear mount and 19 inch Rack mountable type panel
11. Power supply DC12Volt, Universal Type Switch 100~230VAC, 50/60Hz

SPECIFICATIONS

Type of Switcher:	4 in To 8 out, VGA (RGBHV)-Audio Matrix Switcher
Input ports:	4x VGA (RGBHV) via HD-15p VGA connector 4x Stereo Audio (AR/AL), Via 1x ϕ 3.5mm Ear Phone Jack
Output ports:	8x VGA (RGBHV) via HD-15p VGA connector 8x Stereo Audio (AR/AL), Via 1x ϕ 3.5mm Ear Phone Jack
Video Bandwidth :	325MHz (-3db), 200mVp-p
Video Supported:	Higher resolution formats HD 1920x1200 (WUXGA)
Audio Supported:	Stereo Audio(AR/AL)
Low all hostile crosstalk:	-83 db@5MHz
Controls:	IR remote, Select buttons on the front panel & RS232
PC RS232 Control :	RS232 interface serial via DRV on a PC
Gain control:	60MHz 0.1 db gain flatness
Chassis Material:	Metal thin=1mm
Safety Approvals:	CE, FCC, RoHS(2002/95/EC).
Dimensions (LWH):	19" x 7.87" x 1.73" (482mm x 200mm x 44mm)
Power Supply:	DC12V / 1A~2A (consumption 800mA Max) Use Universal Switch Type 50/60Hz,100~230 VAC
Shipping Weight :	2.25 Kgs / 3.96 lb

RS-232 SERIAL INTERFACE

RS-232 SERIAL INTERFACE CONNECT a PC or CONTROL SYSTEM

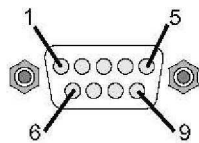

RS-232 SERIAL INTERFACE

Pin	RS-232	Definition
1	-----	Not used
2	TX	Transmitter
3	RX	Receiver
4	-----	Not used
5	GND	Ground
6	-----	Not used
7	-----	Not used
8	-----	Not used
9	-----	Not used

RS232

The Matrix switcher can be controlled via the RS-232 serial control port to allow for interfacing to a PC, or similar third party control system.

The serial communication parameters are 9600 baud, 8 bit, No Parity and 1 stop bit - this is often referred to as 9600 8N1. When the unit recognizes a complete command it will perform the requested action - there is no delimiter character required.

The unit does not send out a message when a value is changed from the front panel or by IR control. If the unit needs to be controlled via the front panel in addition to the RS232 control, you should regularly poll the unit status to ensure the control system accurately reflects the current settings.

PROTOCOL COMMANDS

To Switch Inputs to Outputs

`SBI0X00Y` - Where X is Output Number (1-8) and Y is Input Number (1-4)

Unit will respond with

`SBUD0X0Y` - Where X is Output Number (1-8) and Y is Input Number (1-4)

Example : Send Input 4 to Output 8

`SBI04008` -Send

`SBUD0408` -Rcvd

RS-232 PROTOCOL COMMANDS

MORE STUFF FOR AB-4148



Note: Turning the unit System Power Off over RS232 will extinguish the LED channel display leaving only the Power Switch LED on. The Video and Audio outputs will also mute. While the unit is turned off by RS232 it will continue to accept and act upon switching commands. For example, if the unit is in the off mode (via RS232) and you send a command to switch an input to an output, that route will complete and the video and audio will now appear on that channel only. The front panel LED channel display for that particular output will also show the input selected (for that single output channel only). The remaining LED's will remain off and video and audio outputs muted. The unit will still return status and change messages in response to commands sent while in Power Off state. A hard reset command (SBALLRST) will return the unit to normal operation and also unlock the front panel.

Power Off mode.

SBSYSMOF - Put system into Standby (Soft Power Off)
SBSYSMON - Bring unit out of Standby (Soft Power On)

Unit will respond with

SBALOFAK - Unit is in Standby
SBALONAK - Unit is no longer in Standby

Example : Put Unit in Standby (Soft Power)

SBSYSMOF -Send
SBALOFAK -Rcvd

FRONT PANEL LOCK



Note : Hard resetting the unit will unlock the Front Panel controls.

SBSYSMLK - When front panel is locked, changes can only be made by RS232
SBSYSMUK - Front Panel Unlock

Unit will respond with

SBSYSLOK - Front Panel has been Locked
SBSYSULK - Front Panel has been Unlocked

Example : Lock Front Panel Buttons

SBSYSMLK -Send
SBSYSLOK -Rcvd

UNIT RESET

SBALLRST - Reset every output to Input 1

Unit will respond with

SBRSTACK - Unit has reset each Output to Input 1

Example : Reset all outputs to Input 1

SBALLRST -Send
SBRSTACK -Rcvd

CONNECTING THE HARDWARE

Please study the panel drawings below and become familiar with the signal input-output, Power requirements plus any controls present.

Before using the switcher, please take the time to make certain that the device you wish to connect to its inputs is functioning properly in all respects. Verify that the video and audio signals are present and are being displayed properly on a suitable device.

If all is well connect the appropriate cables between the output of the device you wish to distribute to output(s) of the switcher to the various devices you wish to feed a signal to. Lastly, connect the AC to DC adaptor, connect the DC connector to the switcher first and then plug the adaptor into a functional AC outlet.

TYPICAL APPLICATION

4x VGA-Audio source devices to 8x VGA-Audio Display Matrix Switcher AB-4148

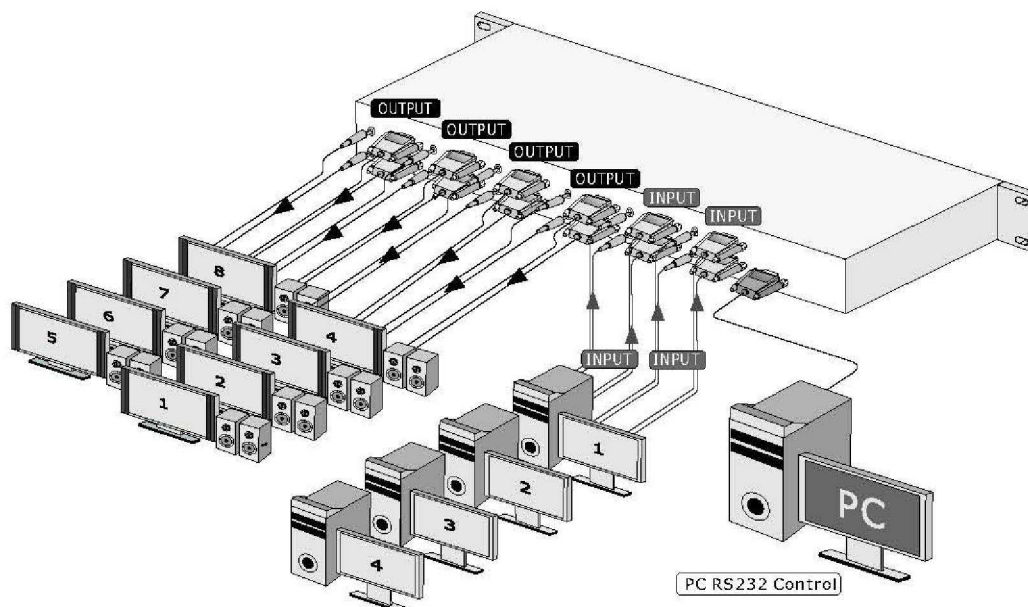

INSTALLING

CONTROL PORTS :

1. IR REMOTE - IR Remote Controller
2. RS 232 Interface - RS 232 interface system

INPUTS 1 ~ 4 PORT VGA SOURCE DEVICE SIGNALS :

- VIDEO - VGA (RGBHV), connector with HD-15p (D-Sub)
AUDIO - Stereo Audio (AR/AL), Connector via OD3.5mm Ear phone Jack

OUTPUTS 1 ~ 8 PORT VGA CONNECT TO DISPLAY MONITOR SIGNALS :

- VIDEO - VGA (RGBHV), connector with HD-15p (D-Sub)
AUDIO - Stereo Audio (AR/AL), Connector via OD3.5mm Ear phone Jack

AB-4148 SUPPORT VGA FOUR INPUTS MATRIX TO EIGHT SWITCH OUTPUTS
SUPPORT CONTROL IR & RS 232 INTERFACE CONTROL FROM A PC

LIMITED WARRANTY

WARRANTY

This product is warranted against defects in materials and workman ship for a period of **1 year** from the date of purchase.

Should this product prove defective within this warranty period, the manufacturer, at its option, shall repair this product without charge, to whatever extent it shall deem necessary to restore said product to proper operation condition.

This warranty does not apply if the fault has been caused by misuse, improper handling care, electrical or mechanical abuse, and abnormal operating condition or non- authorized modification to the product.

If repairs are necessary under the warranty policy, the original purchaser must return the product to local distributor, freight prepaid.

After repairs are complete, the product will be returned.

REGULATORY COMPLIANCE

The product complies with the relevant standards for CE, FCC and RoHS approval.

The power Adaptor/Supply has been tested for compliance with UL.CSA and CE standards.

TROUBLESHOOTING

If you experience a <no signal> with this switcher or distributor outputs, first make certain that the signal being fed to its inputs is acceptable.

Disconnect the cables from the this switcher or distributor inputs and connect them directly to an appropriate monitoring device, if you do not see or hear a signal the problem may well be he signal source itself. Also check that the AC outlet you have used to power the switcher or distributor is actually providing power as a wall switch often controls an AC outlet.

The second most common problem with this switcher or distributor revolves around the cables, Inspect the cables for loose connectors or cable damage such as crushed cable or cables with cuts or nicks. Replace any cable exhibiting these problem.

You also must use the highest quality cables if you want to achieve the best results. Poor quality cables will poor quality signals.

