

# SB-6335T5

5-Play HDBaseT™ PoH TRANSMITTER up to 330 Feet (100M)  
(Single LAN, 2-way IR, RS-232, HDMI)



### IMPORTANT WARRANTY INFORMATION.

*If you remove the HDMI screw posts, you must use the provided HDMI Locking Post replacement screws to keep the internal HDMI jack secure. Removing the HDMI screws without installing the HDMI Locking Post replacement screws will void your warranty.*



## SAFETY INFORMATION



1. To ensure the best results from this product, please read this manual and all other documentation before operating your equipment. Retain all documentation for future reference.
2. Follow all instructions printed on unit chassis for proper operation.
3. To reduce the risk of fire, do not spill water or other liquids into or on the unit, or operate the unit while standing in liquid.
4. Make sure power outlets conform to the power requirements listed on the back of the unit. Keep unit protected from rain, water and excessive moisture.
5. Do not attempt to clean the unit with chemical solvents or aerosol cleaners, as this may damage the unit. Dust with a clean dry cloth.
6. Do not use the unit if the electrical power cord is frayed or broken. The power supply cords should be routed so that they are not likely to be walked on or pinched by items placed upon or against them, paying particular attention to cords and plugs, convenience receptacles, and the point where they exit from the appliance.
7. Do not force switched or external connections in any way. They should all connect easily, without needing to be forced.
8. Always operate the unit with the AC ground wire connected to the electrical system ground. Precautions should be taken so that the means of grounding of a piece of equipment is not defeated.
9. AC voltage must be correct and the same as that printed on the rear of the unit. Damage caused by connection to improper AC voltage is not covered by any warranty.
10. Turn power off and disconnect unit from AC current before making connections.
11. Never hold a power switch in the "ON" position.
12. This unit should be installed in a cool dry place, away from sources of excessive heat, vibration, dust, moisture and cold. Do not use the unit near stoves, heat registers, radiators, or other heat producing devices.
13. Do not block fan intake or exhaust ports. Do not operate equipment on a surface or in an environment which may impede the normal flow of air around the unit, such as a bed, rug, carpet, or completely enclosed rack. If the unit is used in an extremely dusty or smoky environment, the unit should be periodically "blown free" of foreign dust and matter.
14. To reduce the risk of electric shock, do not remove the cover. There are no user serviceable parts inside. Refer all servicing to qualified service personnel. There are no user serviceable parts inside.
15. When moving the unit, disconnect input ports first, then remove the power cable; finally, disconnect the interconnecting cables to other devices.
16. Do not drive the inputs with a signal level greater than that required to drive equipment to full output.
17. The equipment power cord should be unplugged from the outlet when left unused for a long period of time.
18. Save the carton and packing material even if the equipment has arrived in good condition. Should you ever need to ship the unit, use only the original factory packing.
19. Service Information Equipment should be serviced by qualified service personnel when:
  - A. The power supply cord or the plug has been damaged.
  - B. Objects have fallen, or liquid has been spilled into the equipment.
  - C. The equipment has been exposed to rain.
  - D. The equipment does not appear to operate normally, or exhibits a marked change in performance.
  - E. The equipment has been dropped, or the enclosure damaged.

# TABLE OF CONTENTS

## HDBaseT™ with Ethernet 100M EXTENDER Series

Thank you for purchasing the SB-6335T5 HDBaseT™ with PoH Transmitter. You will find this unit easy to install and highly reliable but it is essential that you read this manual thoroughly before attempting to use the converter.

### CONTENTS

INTRODUCTION .....	1
FEATURES & SPECIFICATIONS .....	2
CONTENTS .....	2
TYPICAL HOOKUP & OPERATION .....	3
IR EXTENDER .....	4
RACK MOUNT .....	6

### INTRODUCTION

Congratulations on your purchase of one of the most innovative HDMI 1.4a over single category cable with POH (Power Over HDBaseT™) Transmitters on the market today. The SB-6335T5 HDBaseT™ Transmitter can transmit HDMI, Ethernet, POH with power (48VDC) and IR remote input signals to the receiver or output destination and the RS-232 interface I/O signal to the HDBaseT™ Receiver (SB-6335R5 POH) via a single LAN (category) cable for a long distances up to 328 feet (100M) maximum. The SB-6335T5 Transmitter uses a single UTP/FTP (category cable) CAT5e, CAT6, CAT6a or CAT7 via RJ-45 8P8C female socket (Supports 568a/b). This product supports higher full HD HDMI 1.4a, resolutions of 480i/p, 720p, 1080i/p or high quality 4K2K that is identical to the high quality full HDMI 1.4 source signals. This Transmitter is useful for sending the HDMI digital video / multi-channel audio format, IR remote in or out, Ethernet, RS-232 in/out, POH and control signals via a single category cable transmitted to the HDBaseT™ Receiver.

#### CONFORMANCE TEST REPORT

FOR **EN 61000-6-1 / EN 61000-6-3** 

REPORT NUMBER: 09-07-MAS-282-18-R

FOR **FCC 47 CFR/Part 15 Subpart B** 

REPORT NUMBER: 09-07-MAS-282-19-R

Model Number: SB-6335T5

Comment Number: SB-6215, SB-6215R, SB-6215RE, SB-6220R SB-6220RE, SB-6240R, SB-6240RE, SB-6335T, SB-6335R, SB-6320T, SB-6320R

Input: HDMI (with DVI -Audio)  
Output: HDBaseT™ via CAT6/6a/7 Cable  
Power Input: +DC48V, 1A 



## LOOK A PUPPY!! NOW READ THIS!!



### IMPORTANT WARRANTY INFORMATION.

If you remove the HDMI screw posts, you must use the provided HDMI Locking Post replacement screws to keep the internal HDMI jack secure. Removing the HDMI screws without installing the HDMI Locking Post replacement screws will void your warranty.

### SAFETY PRECAUTIONS

Please read all instructions before attempting to unpack, install or operate this equipment and before connecting the power supply. Please keep the following in mind as you unpack and install this equipment:

- Always follow basic safety precautions to reduce the risk of fire, electrical shock and injury to persons.
- To prevent fire or shock hazard, do not expose the unit to rain, moisture or install this product near water.
- Never spill liquid of any kind on or into this product.
- Never push an object of any kind into this product through any openings or empty slots in the unit, as you may damage parts inside the unit.
- Do not attach the power supply cabling to building surfaces.
- Use only the supplied power supply unit (PSU). Do not use the PSU if it is damaged.
- Do not allow anything to rest on the power cabling or allow any weight to be placed upon it or any person walk on it.
- To protect the unit from overheating, do not block any vents or openings in the unit housing that provide ventilation and allow for sufficient space for air to circulate around the unit.

### DISCLAIMERS

The information in this manual has been carefully checked and is believed to be accurate. We assume no responsibility for any infringements of patents or other rights of third parties which may result from its use.

We assume no responsibility for any inaccuracies that may be contained in this document. We make no commitment to update or to keep current the information contained in this document.

We reserve the right to make improvements to this document and/or product at any time and without notice.

### COPYRIGHT NOTICE

No part of this document may be reproduced, transmitted, transcribed, stored in a retrieval system, or any of its part translated into any language or computer file, in any form or by any means — electronic, mechanical, magnetic, optical, chemical, manual, or otherwise — without express written permission and consent.

© Copyright 2016. All Rights Reserved.

Version 2.2 JULY 2016

### TRADEMARK ACKNOWLEDGMENTS

All products or service names mentioned in this document may be trademarks of the companies with which they are associated.

# FEATURES & SPECIFICATIONS

## FEATURES

- HDBaseT™ Transmitter extends the HDMI signal over a single category cable
- Transmits HDMI, IR in/out, Ethernet, RS-232 I/O and POH (Power Over HDBaseT™) signals over a category cable using a CAT6, CAT6a and CAT7 (UTP or FTP) cable for 568a or 568b
- HDBaseT™ link speeds of up to 3.4Gbps, HDMI 1.4, full HD 4K2K signal, HDCP compliant
- Supports digital RGB 36bits, HDMI digital video TMDS, digital multi-channel audio format
- Extends higher quality full HD DVI video WUXGA 1920x1200 resolution
- Supports High Definition worldwide range resolutions 480p, 720p, 1080i/1080p-60Hz and 4K2K
- Extends long distances up to 328 feet (100M) between HDBaseT™ Transmitter and Receiver
- Supports wall mount and rack mount installations total 13 pcs. into one 19 inch 4U rack mount
- Power input via DC with low power consumption (Full load 750mA)
- Power supply universal power switch 50/60Hz,100~240VAC

## SPECIFICATIONS

- **Type of Extender:** HDBaseT™ Transmitter transmits the HDMI signal over a single category cable
- **Input Signals:** HDMI with Digital Video (TMDS)/Audio 0.5~1.0vPP, DDC 5Vpp
- **HDBaseT™ Supports:** HDMI 1.4 Standard, DVI and HDCP Compliant
- **Video Supported:** HDMI and DVI TMDS formats for 1920x1200 resolutions up to 3.4Gbps Digital RGB 36bits deep color, 3D 1.4a HDMI format
- **Audio I/O Supported:** Multi-channel Audio Formats 5.1 / 7.1, MAT(MLP), Dolby Digital, Dolby TrueHD, Dolby Digital Plus, DTS, DTS-ES 6.1, DTS-HD, DTS-HD-HRA, DTS-HD Master, (PCM-2CH)
- **PoH Supported:** With power over HDBaseT™
- **Category Cable Supported:** CAT6, CAT6a, CAT7 use UTP or FTP cable
- **Supports HDMI Resolutions:** 480p, 720p, 1080i/1080p@60Hz or 4K2K@24Hz
- **Scan Rate Accepted:** Supports HDMI full HD resolutions; Frequency 24Hz to 60Hz
- **Control:** (1) IR in, (1) IR out, (1) RS-232 I/O and (1) Ethernet series interface
- **IR Infrared Frequency:** 38KHz
- **Extender Distance:** Up to 328 feet (100M) via (UTP or FTP CAT6 100M cable)
- **Safety Approvals:** CE, FCC, VCCI, REACH & WEEE
- **Dimensions (LxWxH):** 5.45 x 5.12 x 1.14 in
- **Wall Mount:** Wall mount pack (p/n:VM-1inch-L80MM)
- **Rack Mount:** Total 13 pcs installs into a 19 inch 4U Rack mount
- **Weight:** 1.1 lb (Unit only) / 3.1 lb (Net)
- **Power Consumption:** Max 750mA (Full load 1080p-60Hz signal with use DC12V input)
- **Power Supply:** Extra Power Input +48VDC, 1A (Universal Type 50/60Hz, 100~240VAC)

As product improvements are continuous, specifications are subject to change and without notice.

## PACKAGE CONTENTS

Check that you have the following components:

- SB-6335T5 HDBaseT™ Transmitter console
- HDMI Locking Post Replacement Screws
- Users Guide
- AC/DC Adapter: 48VDC/1A (universal power switch 50/60Hz,100~240VAC)
- *Optional: SB-100 IR Extender Receiver Set*
- *Optional: SB-101 IR Extender Transmitter Set*
- *Optional: SB-100C IR Extender Receiver Cable (6.5ft (2M))*
- *Optional: SB-101C IR Extender Transmitter Cable (6.5ft (2M))*
- *Optional: 1 in High wall mount pack (Part # WM-1INCH-L80MM)*
- *Optional: CAT6 Category cable distance 328 feet (100M), (P/N: UTP6-100)*

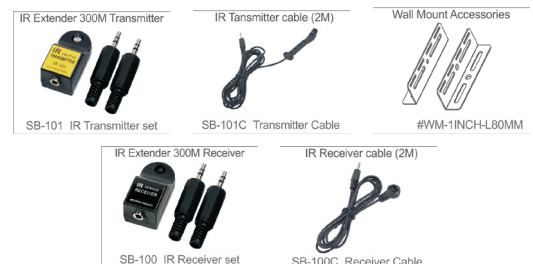

# TYPICAL HOOKUP AND OPERATION

## SB-6335T4 FRONT

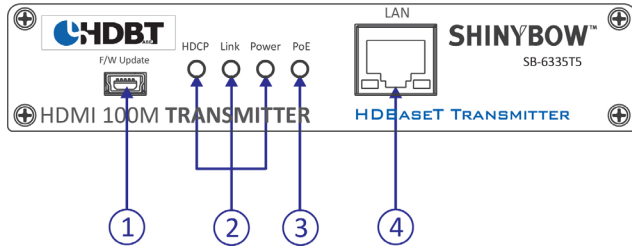

1. Firmware update port
2. **STATUS VIA LED SHOW OUT:** HDCP, LINK & POWER
3. PoH turns ON the LED
4. Ethernet path to the HDBaseT™ Receiver

## SB-6335T4 BACK

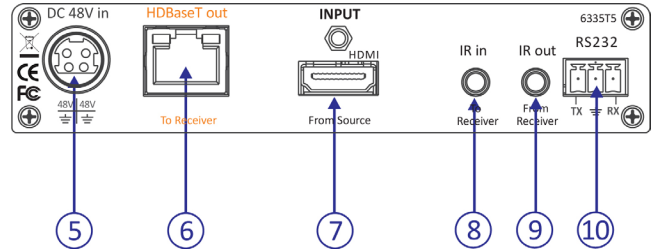

5. **DC INPUT:** DC48V, 1A, (Din-4pins Male Plug)
6. **RJ-45 OUT:** HDBaseT™ output signal to the HDBaseT™ Receiver
7. **HDMI IN:** HDMI input signal from the HDMI source device
8. **IR IN:** Sends IR signal to the HDBaseT™ Receiver
9. **IR OUT:** Receives IR signal from the HDBaseT™ Transmitter
10. **RS-232 I/O:** RS-232 I/O serial interface via HDBaseT™

If you remove the HDMI screw posts, you must use the provided HDMI Locking Post replacement screws to keep the internal HDMI jack secure. Removing the HDMI screws without installing the HDMI Locking Post replacement screws will void your warranty.

### Safeguards and Precautions

- A. Keep this unit away from fire, extremely hot areas, water or moisture of any kind.
- B. Do not place this unit on any support that is not firm, level and strong.
- C. Do not service the unit yourself. Opening the unit's housing will void the warranty.
- D. Servicing must be by Shinybow or by an authorized technician.
- C. Illegal duplication of copyrighted material is strictly prohibited by Federal Laws.

## INSTALLING DIAGRAM

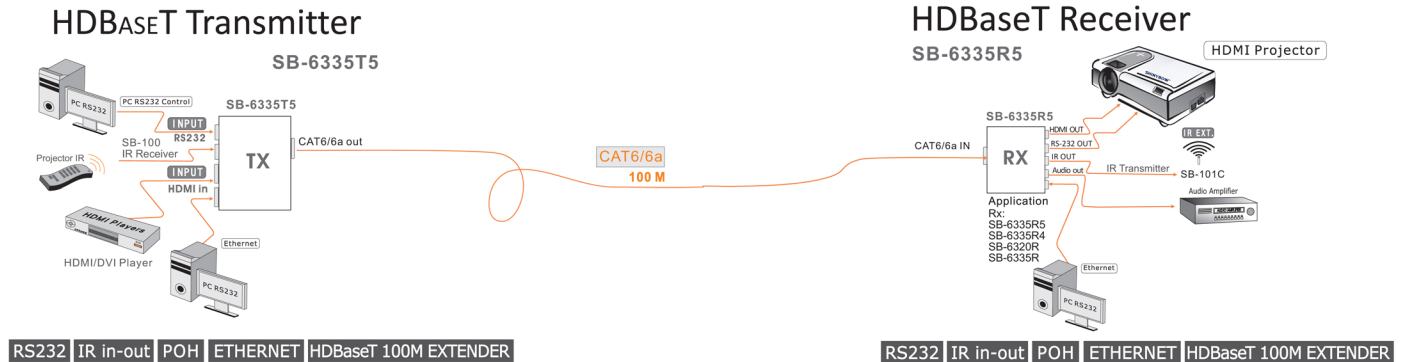

# IR EXTENDER

## IR EXTENDER

### 1. SB-100 IR 300M Receiver

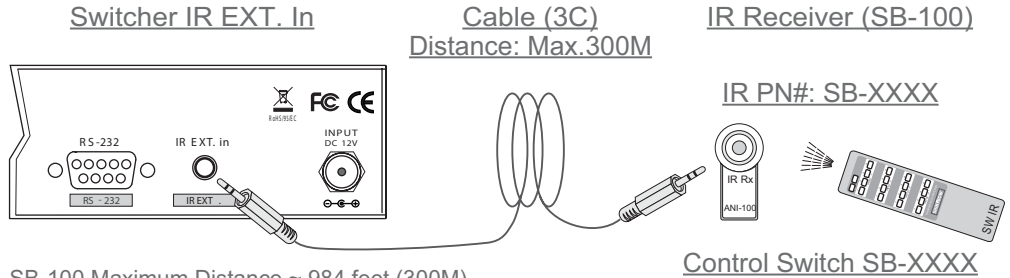

SB-100 Maximum Distance ~ 984 feet (300M)

The SB-100 IR Receiver is required when using the port "ALL in" Jack.

### 2. SB-100C IR 2M Receiver

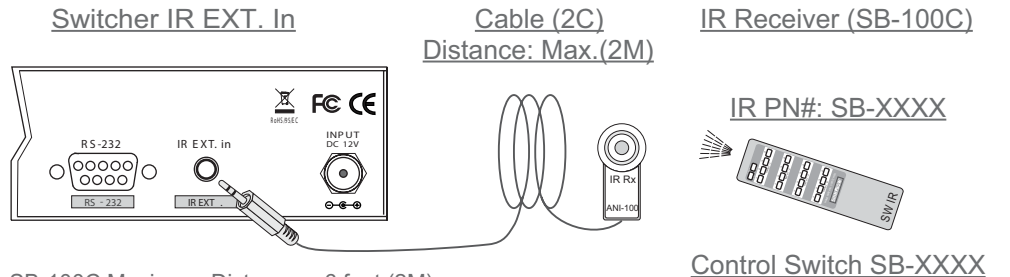

SB-100C Maximum Distance ~ 6 feet (2M)

The SB-100C IR Receiver will not function on the port "ALL in" Jack.

\*\*\* When you plug the External IR extender into the switcher, the front panel IR receiver remains active. \*\*\*

Pin configuration for IR 984 feet (300M) Extender Receiver such as SB-100 compatible

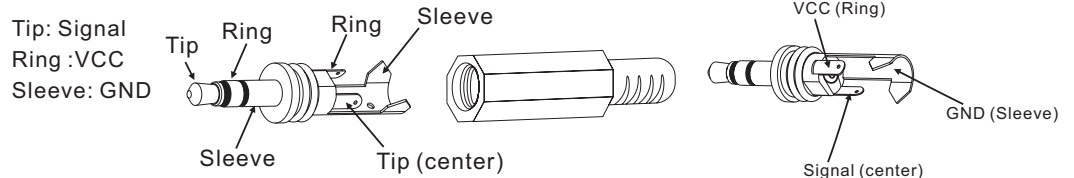

SB-100 Receiver and SB-101 Transmitter The DISTANCE maximum ~ 984 feet (300M)

Pin configuration for IR Receiver 6 feet (2M) cable such as SB-100C compatible

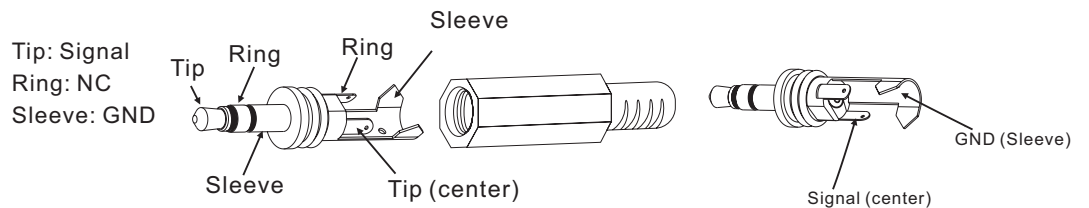

SB-100 Receiver and SB-101C Transmitter The DISTANCE maximum ~ 984 feet (300M)

**Note:** The External IR jack has voltage on the "Ring" portion of a 3-conductor plug. You must use a 3-conductor plug (aka: stereo plug). Using a 2-conductor plug will short out the power supply. Always make connections with the switcher power off.

# IR EXTENDER

## IR EXTENDER

### 1. SB-101 IR 300M Transmitter

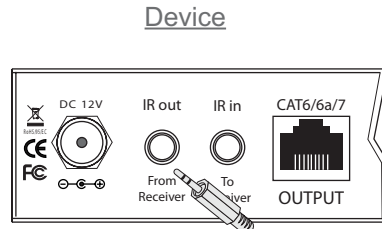

Cable (3C)

IR Transmitter (SB-101)



SB-101 Maximum Distance ~ 984 feet (300M)

### 2. SB-101C IR 2M Transmitter

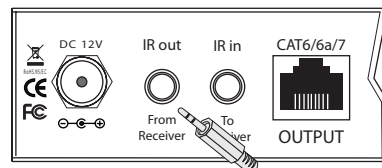

Cable (3C)

IR Transmitter (SB-101C)

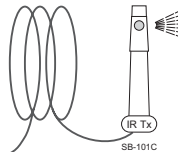

SB-101C Maximum Distance ~ 6 feet (2M)

\*\*\* When you plug the External IR extender into the switcher, the front panel IR transmitter remains active. \*\*\*

### PIN CONFIGURATION:

#### SB-101 and SB-101C Transmitter Pin configuration



Tip: Signal  
Ring :VCC  
Sleeve: GND

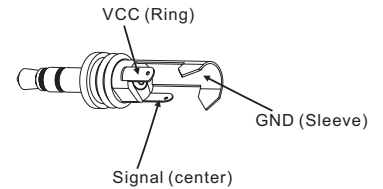
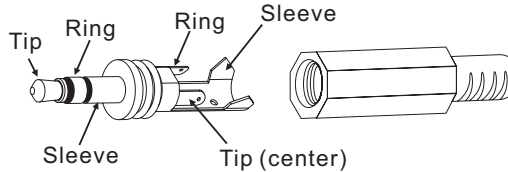

SB-101 Maximum Distance ~ 984 feet (300M)



Tip: Signal  
Ring: NC  
Sleeve: GND

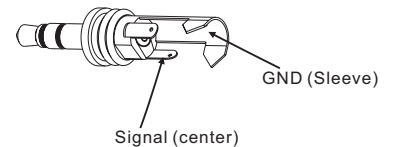
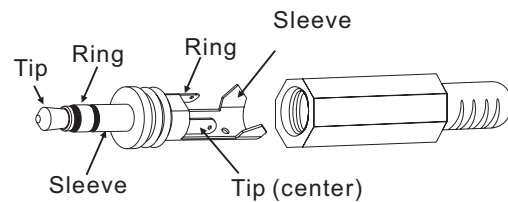

SB-101C Maximum Distance ~ 6 feet (2M)

**Note:** The External IR jack has voltage on the "Ring" portion of a 3-conductor plug. You must use a 3-conductor plug (aka: stereo plug). Using a 2-conductor plug will short out the power supply. Always make connections with the switcher power off.

# RACK MOUNT

## SB-6069

### SB-6335T5/SB-6335R5 19 INCH 4U-10P RACK MOUNT

Model No.: #4U-10p-L130MM

SB-6335T5/SB-6335R5 4U Ear mount pairs

Parts No.: MEER6069ER13000

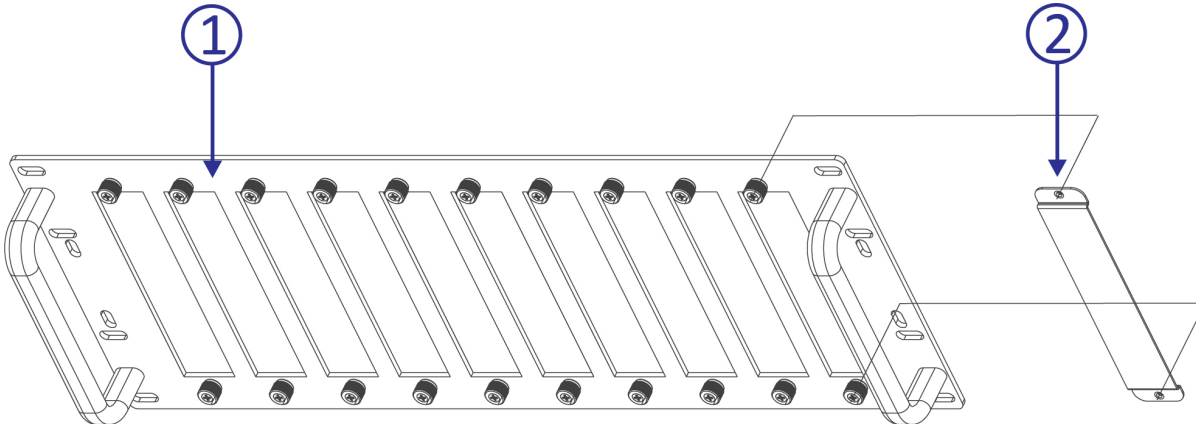

Model No.: #4U-10p-L130MM-COV

SB-6335T5/SB-6335R5 4U Ear mount pairs

Parts No.: MEER6069ER11000

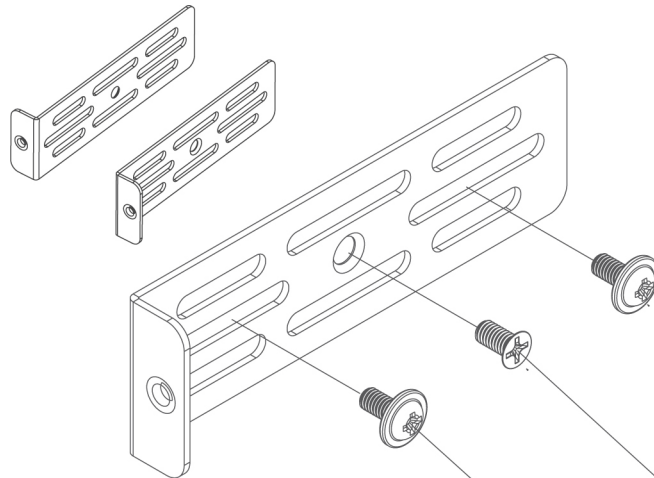
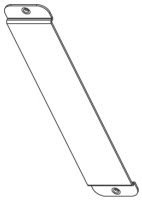

Model No.: #4U-10p-L80MM-EAR

SB-6335T5/SB-6335R5 4U Ear mount pairs

Parts No.: MEER6320ER11001

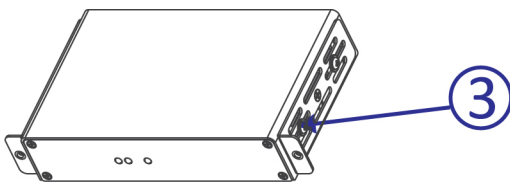

P/N: TP-ISO-M3x6mm(x2)  
(MESCW30006ISO02)

P/N: ISO-M3x6mm  
(MESCF30006ISO02)



# RACK MOUNT

## SB-6069

Complete 19 inch 4U rack mount

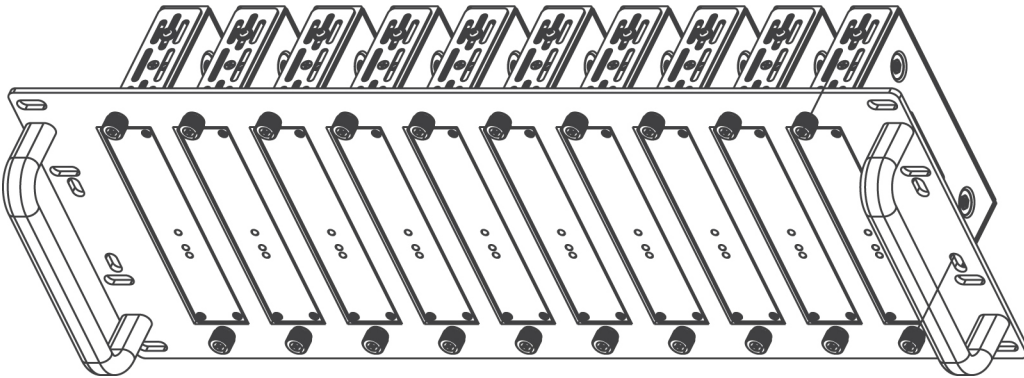

Install Application: SB-6335T5/SB-6335R5

SB-6335T5/SB-6335R5: Wall mount accessories

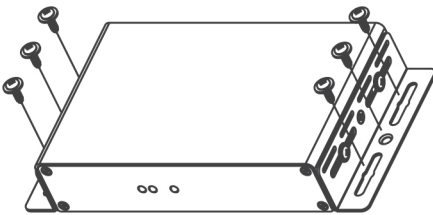

Model No.: #WM-1INCH-L80MM

SB-6335T5/SB-6335R5 Wall mount pairs

Parts No.: MEER6320ER11000

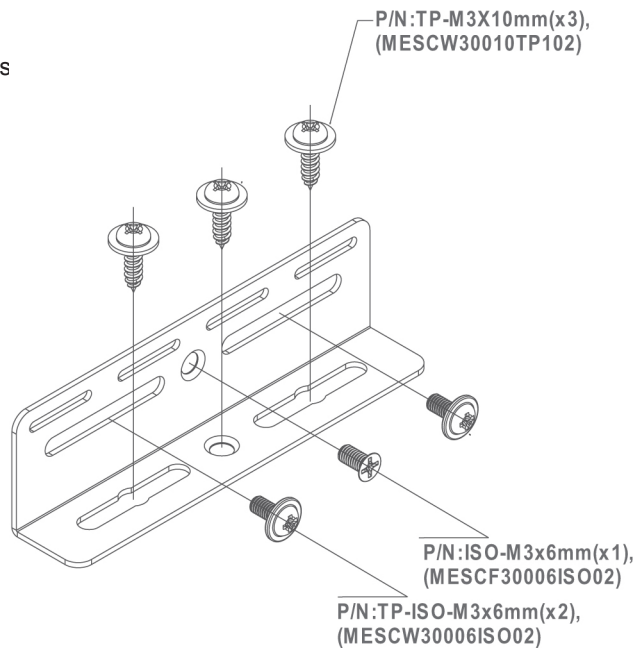
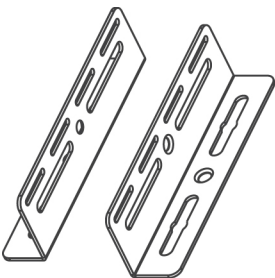

THIS PAGE IS INTENTIONALLY LEFT BLANK.

# LIMITED WARRANTY

PLEASE READ THE FOLLOWING TERMS AND CONDITIONS CAREFULLY BEFORE USING THIS HARDWARE, COMPONENTS AND SOFTWARE PROVIDED BY, THROUGH OR UNDER SHINYBOWUSA, INC (COLLECTIVELY, THE "PRODUCT"). By using installing or using the Product, you unconditionally signify your agreement to these Terms and Conditions. If you do not agree to these Terms and Conditions, do not use the Product and return the Product to SHINYBOWUSA, Inc. at the return address set forth on the Product's packing label at your expense. SHINYBOWUSA, Inc. may modify these Terms and Conditions at anytime, without notice to you.

## RESTRICTIONS ON USE OF THE PRODUCT

It is your responsibility to read and understand the installation and operation instructions, both verbal and in writing, provided to you with respect to the Product. You are authorized to use the Product solely in connection with such instructions. Any use of the Product not in accordance with such instructions shall void any warranty pertaining to the Product. Any and all damages that may occur in the use of the Product that is not strictly in accordance with such instructions shall be borne by you and you agree to indemnify and hold harmless SHINYBOWUSA, Inc. from and against any such damage.

The Product is protected by certain intellectual property rights owned by or licensed to SHINYBOWUSA. Any intellectual property rights pertaining to the Product are licensed to you by SHINYBOWUSA, Inc. and/or its affiliates, including any manufacturers or distributors of the Product (collectively, "SHINYBOWUSA") for your personal use only, provided that you do not change or delete any proprietary notices that may be provided with respect to the Product.

The Product is sold to you and any use of any associated intellectual property is deemed to be licensed to you by SHINYBOWUSA for your personal use only. SHINYBOWUSA does not transfer either the title or the intellectual property rights to the Product and SHINYBOWUSA retains full and complete title to the intellectual property rights therein. All trademarks and logos are owned by SHINYBOWUSA or its licensors and providers of the Product, and you may not copy or use them in any manner without the prior written consent of SHINYBOWUSA, which consent may be withheld at the sole discretion of SHINYBOWUSA.

The functionality and usability of the Product is controlled by SHINYBOWUSA, Inc. from its offices within the State of Texas, United States of America. SHINYBOWUSA makes no representation that materials pertaining to the Product are appropriate or available for use in other locations other than the shipping address you provided with respect thereto. You are advised that the Product may be subject to U.S. export controls.

## DISCLAIMERS AND LIMITATION OF LIABILITY

SHINYBOWUSA may change or modify the Product at any time, from time to time.

THE PRODUCT IS PROVIDED "AS IS" AND WITHOUT WARRANTIES OF ANY KIND EITHER EXPRESS OR IMPLIED. SHINYBOWUSA DOES NOT WARRANT OR MAKE ANY REPRESENTATIONS REGARDING THE USE OR THE RESULTS OF THE USE OF THE PRODUCT'S CORRECTNESS, ACCURACY, RELIABILITY, OR OTHERWISE.

SHINYBOWUSA has no duty or policy to update any information or statements pertaining to the Product and, therefore, such information or statements should not be relied upon as being current as of the date you use the Product. Moreover, any portion of the materials pertaining to the Product may include technical inaccuracies or typographical errors. Changes may be made from time to time without notice with respect to the Product.

TO THE FULLEST EXTENT PERMISSIBLE PURSUANT TO APPLICABLE LAW, SHINYBOWUSA DISCLAIMS ALL WARRANTIES, EXPRESS OR IMPLIED, INCLUDING, BUT NOT LIMITED TO IMPLIED WARRANTIES OF MERCHANTABILITY, FITNESS FOR A PARTICULAR PURPOSE AND NON-INFRINGEMENT. SHINYBOWUSA DOES NOT WARRANT THE ACCURACY, COMPLETENESS OR USEFULNESS OF ANY INFORMATION WITH RESPECT TO THE PRODUCT. SHINYBOWUSA DOES NOT WARRANT THAT THE FUNCTIONS PERTAINING TO THE PRODUCT WILL BE ERROR-FREE, THAT DEFECTS WITH RESPECT TO THE PRODUCT WILL BE CORRECTED, OR THAT THE MATERIALS PERTAINING THERETO ARE FREE OF DEFECTS OR OTHER HARMFUL COMPONENTS. SHINYBOWUSA WILL USE ITS REASONABLE EFFORTS TO CORRECT ANY DEFECTS IN THE PRODUCT UPON TIMELY WRITTEN NOTICE FROM YOU NOT TO EXCEED 10 BUSINESS DAYS AFTER RECEIPT BY YOU OF THE PRODUCT, BUT YOU (AND NOT SHINYBOWUSA) ASSUME THE ENTIRE COST OF ALL NECESSARY SERVICING, REPAIR AND CORRECTION THAT WAS CAUSED BY YOU UNLESS OTHERWISE AGREED TO IN A SEPARATE WRITING BY SHINYBOWUSA.

UNDER NO CIRCUMSTANCES, INCLUDING, BUT NOT LIMITED TO, NEGLIGENCE, SHALL SHINYBOWUSA BE LIABLE FOR ANY SPECIAL OR CONSEQUENTIAL DAMAGES THAT RESULT FROM THE USE OF, OR THE INABILITY TO USE THE PRODUCT IN ACCORDANCE WITH ITS SPECIFICATIONS, EVEN IF SHINYBOWUSA OR ITS REPRESENTATIVES HAVE BEEN ADVISED OF THE POSSIBILITY OF SUCH DAMAGES. IN NO EVENT SHALL SHINYBOWUSA'S TOTAL LIABILITY TO YOU FROM ALL DAMAGES, LOSSES, AND CAUSES OF ACTION (WHETHER IN CONTRACT, OR OTHERWISE) EXCEED THE AMOUNT YOU PAID TO SHINYBOWUSA, IF ANY, FOR THE PRODUCT.

**END OF DOCUMENT**

122 Rose Ln. Suite 303 | Frisco, Texas 75034

1-877-SHINY-USA

1-877-744-6987

1-972-377-2508

[sales@shinybowusa.com](mailto:sales@shinybowusa.com)

[www.shinybowusa.com](http://www.shinybowusa.com)

**SHINYBOW™ USA**  
MULTIMEDIA AUDIO AND VISUAL