

SB-5645LCM

4x4 HDMI Matrix Routing Switcher w/ Full EDID Management/Learning



IMPORTANT WARRANTY INFORMATION.

If you remove the HDMI screw posts, you must use the provided HDMI Locking Post replacement screws to keep the internal HDMI jack secure. Removing the HDMI screws without installing the HDMI Locking Post replacement screws will void your warranty.



SAFETY INFORMATION



1. To ensure the best results from this product, please read this manual and all other documentation before operating your equipment. Retain all documentation for future reference.
2. Follow all instructions printed on unit chassis for proper operation.
3. To reduce the risk of fire, do not spill water or other liquids into or on the unit, or operate the unit while standing in liquid.
4. Make sure power outlets conform to the power requirements listed on the back of the unit. Keep unit protected from rain, water and excessive moisture.
5. Do not attempt to clean the unit with chemical solvents or aerosol cleaners, as this may damage the unit. Dust with a clean dry cloth.
6. Do not use the unit if the electrical power cord is frayed or broken. The power supply cords should be routed so that they are not likely to be walked on or pinched by items placed upon or against them, paying particular attention to cords and plugs, convenience receptacles, and the point where they exit from the appliance.
7. Do not force switched or external connections in any way. They should all connect easily, without needing to be forced.
8. Always operate the unit with the AC ground wire connected to the electrical system ground. Precautions should be taken so that the means of grounding of a piece of equipment is not defeated.
9. AC voltage must be correct and the same as that printed on the rear of the unit. Damage caused by connection to improper AC voltage is not covered by any warranty.
10. Turn power off and disconnect unit from AC current before making connections.
11. Never hold a power switch in the "ON" position.
12. This unit should be installed in a cool dry place, away from sources of excessive heat, vibration, dust, moisture and cold. Do not use the unit near stoves, heat registers, radiators, or other heat producing devices.
13. Do not block fan intake or exhaust ports. Do not operate equipment on a surface or in an environment which may impede the normal flow of air around the unit, such as a bed, rug, carpet, or completely enclosed rack. If the unit is used in an extremely dusty or smoky environment, the unit should be periodically "blown free" of foreign dust and matter.
14. To reduce the risk of electric shock, do not remove the cover. There are no user serviceable parts inside. Refer all servicing to qualified service personnel. There are no user serviceable parts inside.
15. When moving the unit, disconnect input ports first, then remove the power cable; finally, disconnect the interconnecting cables to other devices.
16. Do not drive the inputs with a signal level greater than that required to drive equipment to full output.
17. The equipment power cord should be unplugged from the outlet when left unused for a long period of time.
18. Save the carton and packing material even if the equipment has arrived in good condition. Should you ever need to ship the unit, use only the original factory packing.
19. Service Information Equipment should be serviced by qualified service personnel when:
 - A. The power supply cord or the plug has been damaged.
 - B. Objects have fallen, or liquid has been spilled into the equipment.
 - C. The equipment has been exposed to rain.
 - D. The equipment does not appear to operate normally, or exhibits a marked change in performance.
 - E. The equipment has been dropped, or the enclosure damaged.

TABLE OF CONTENTS

HDMI Matrix Switcher Series

Thank you for purchasing the SB-5645LCM 4x4 HDMI Matrix Switcher. You will find this unit easy to install and highly reliable but it is essential that you read this manual thoroughly before attempting to use 4x4 HDMI Matrix switcher.

CONTENTS

INTRODUCTION	1
FEATURES & CONTENTS.....	2
SPECIFICATIONS	3
FRONT PANEL	4
BACK PANEL	7
REMOTE CONTROL	8
RS-232 SERIAL INTERFACE	10
EDID FUNCTIONS	11
IR EXTENDER	14
TYPICAL APPLICATION	15

INTRODUCTION

The SB-5645LCM is a high-performance 4x4 matrix routing switcher for HDMI signals. This switcher supports data rates up to 6.75Gbps, enabling 1080p HDMI formats and UXGA/WUXGA/DVI resolution to any HD display. High Definition Digital signals can be selected and distributed to any (4) outputs simultaneously. The switcher is certified as being fully HDMI and HDCP compliant, with RoHS, CE, FCC certifications. Supports high resolution HDMI sources routed to HDMI displays, monitors, projector or audio receivers. The EDID can be selected between (7) different modes. Control is provided via front panel push buttons, IR remote or via RS-232. A RS-232 Windows GUI interface is provided for matrix routing.

The SB-5645LCM is our next-generation 4x4 HDMI matrix routing switch, designed for multiple sources and displays. There are (4) HDMI connections for inputs and (4) HDMI connections for outputs located on the back panel. This unit has EDID management and EDID memory, including a new feature called "Fast Speed Start[®]" which permits switching between HDMI sources in as little as 2 seconds. The SB-5645LCM supports bandwidth of 6.75Gbps and data rates up to 2.5 Gbps, enabling 1080p HDMI formats and UXGA DVI resolutions.

Building upon our successful 5645p series, the SB-5645LCM's front panel includes an LCD display with (2) data display lines. Functional manual control is achieved through push buttons located on the front panel. External functional control is achieved through a RS-232 connection or through the IR remote control. The RS-232 connection allows functions to be controlled by systems like Control4 (drivers included) or any computerized software/hardware control system.

When using the SB-5645LCM matrix routing switch, one-to-many or many-to-one connections can be established. You can easily connect any input device to any output device. You can also establish a single input device to many output devices, eliminating the need to constantly re-route video input and output cables.

SAFETY PRECAUTIONS

Please read all instructions before attempting to unpack, install or operate this equipment and before connecting the power supply. Please keep the following in mind as you unpack and install this equipment:

- Always follow basic safety precautions to reduce the risk of fire, electrical shock and injury to persons.
- To prevent fire or shock hazard, do not expose the unit to rain, moisture or install this product near water.
- Never spill liquid of any kind on or into this product.
- Never push an object of any kind into this product through any openings or empty slots in the unit, as you may damage parts inside the unit.
- Do not attach the power supply cabling to building surfaces.
- Use only the supplied power supply unit (PSU). Do not use the PSU if it is damaged.
- Do not allow anything to rest on the power cabling or allow any weight to be placed upon it or any person walk on it.
- To protect the unit from overheating, do not block any vents or openings in the unit housing that provide ventilation and allow for sufficient space for air to circulate around the unit.

DISCLAIMERS

The information in this manual has been carefully checked and is believed to be accurate. We assume no responsibility for any infringements of patents or other rights of third parties which may result from its use.

We assume no responsibility for any inaccuracies that may be contained in this document. We make no commitment to update or to keep current the information contained in this document.

We reserve the right to make improvements to this document and/or product at any time and without notice.

COPYRIGHT NOTICE

No part of this document may be reproduced, transmitted, transcribed, stored in a retrieval system, or any of its part translated into any language or computer file, in any form or by any means — electronic, mechanical, magnetic, optical, chemical, manual, or otherwise — without express written permission and consent.

© Copyright 2016. All Rights Reserved.
Version 2.3 JULY 2016

TRADEMARK ACKNOWLEDGMENTS

All products or service names mentioned in this document may be trademarks of the companies with which they are associated.

FEATURES

FEATURES

- (4) HDMI digital source devices matrix switched to (4) HDMI devices
- HDMI digital video w/ embedded audio, DVI format and CEC/HDCP 2.0 compliant
- (7) function keys control and worldwide EDID modes for HDTV resolutions
- Link speeds of up to 6.75Gbps (link clock rate of 225MHz). Supports HDMI 1.4a 3D formats
- Wide range of HD resolutions from PC XGA to WUXGA 1920x1200 and HDTV/DTV resolutions 480i/480p, 576i/576p, 720p, 1080i & 1080p
- Compatible with all HDMI source devices, PC monitors, Plasma HD display, HDTV and audio receivers/amplifiers
- Digital video TMDS formats for resolutions up to 1080p-60 with Deep color 36-bit
- Digital Audio Support: Dolby TrueHD, Dolby Digital, Dolby Digital Plug/ex, DTS, DTS-HD, DTS-HD Master, DTS-EX, PCM, PCM2, LPCM2
- Various User Interface Control:
 - Windows based GUI control via RS-232 port
 - Front panel push button
 - IR remote control
 - Third party RS-232 control (via simple ASCII)
- Supports World Wide Control Functions: ALL/OFF/RECALL/ENTER/MEMORY/EDID/LOCK
- Supports EDID Modes:
 - Internal Modes: AUTO/1080p-2CH/1080p-5.1/1080p-7.1/1080i-2CH/720p-2CH
 - External Modes: Passing mode
- Automatic scanning input & output status via LED show on front panel
- Supports IR remote and IR extender for distances up to ~1000 ft (300M) Maximum
- EDID configuration via internal modes
- Consumer Electronic Control (CEC) switch all open or OFF

The switcher will remember that last state during a power cycle. When power is removed and resorted, the last configuration will be invoked.

PACKAGE CONTENTS

Check that you have the following components:

- SB-5645LCM Matrix Routing Switcher
- Wireless Remote Control
- Rack Mount Kit
- SB-100 IR Extender Receiver Set
- RS-232 driver CD (All Windows Operating Systems)
- RS-232 Cable
- HDMI Locking Post Replacement Screws
- Users Guide
- AC/DC Adapter: 12VDC, 3A
- *Optional: SB-100C IR Extender Receiver Cable (6.5ft (2M))*



LOOK A PUPPY!! NOW READ THIS!!

IMPORTANT WARRANTY INFORMATION.

If you remove the HDMI screw posts, you must use the provided HDMI Locking Post replacement screws to keep the internal HDMI jack secure. Removing the HDMI screws without installing the HDMI Locking Post replacement screws will void your warranty.

SPECIFICATIONS

SPECIFICATIONS

- **Type of Switcher:** (4) HDMI Inputs to (4) HDMI Outputs Matrix Switcher
- **HDMI Support:** HD 1080p@60Hz, H36-bit Deep color, 3D (1.4a) formats
- **HDCP / CEC Support:** HDCP 2.0 Compliant, CEC Compliant
- **Video Bandwidth:** Double Data Rates: 225Mhz, Total 6.75Gbps bandwidth
- **Digital Video Support:** Full HD Resolution: 480i / 480p / 720p / 1080i / 1080p
- **Digital Audio Support:** Multi Audio Formats 5.1 / 7.1, MAT(MLP), Dolby Digital, Dolby TrueHD, Dolby Digital Plus, DTS, DTS-ES 6.1, DTS-HD, DTS-HD-HRA, DTS-HD Master, (PCM-2CH)
- **Controls:**
 - IR remote control
 - IR external port (1) (OD 3.5mm ear phone jack)
 - Select & Function buttons on front panel
 - RS-232 series interface
- **Source Status:** Automatically scans source Inputs via LED
- **Function Control Key:** ALL / OFF / RECALL / ENTER / MEMORY / LOCK / EDID
- **Infrared Frequency:** 38Khz
- **IR External Distance:** ~1000 feet / 300M maximum
- **HDMI I/O Connector:** HDMI Type A - SMD 19pin female type
- **Temperature:** 32°F - 100°F Operation (0°C - 38°C)
- **Dimensions (LxWxH):** 17.5 x 8 x 1.75 in
- **Rack Mount:** 1RU High 19in rack mount (with rack mount)
- **Power Supply:** DC12V / 3A, Universal world wide type 50/60Hz, 100~230VAC
- **Power Consumption:** 2150mA Maximum
- **Safety Approvals:** CE, FCC, RoHS (2002/95/EC)
- **Weight:** 5.5 lb (Unit only) / 8.2 lb (Net)

FRONT PANEL

FRONT PANEL

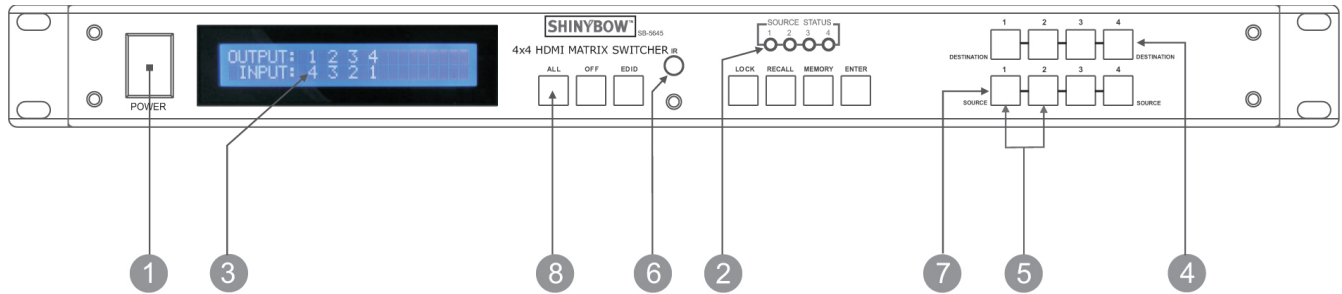

1. POWER SWITCH: The power switch turns the unit on and off. The LCM will illuminate red to indicate that the switcher is ON and is receiving power. The switcher will remember that last state during a power cycle. When power is removed and resorted, the last configuration will be evoked.

2. INPUT STATUS DISPLAY: Input sources 1 to 4 LCM illuminates blue to indicate that a video source is present on that input.

3. OUTPUT STATUS DISPLAY: Each output (destination) channel shows which input (source) is assigned.

4. DESTINATION SELECT BUTTONS: Separate outputs 1 thru 4 select buttons are provided for each destination assignment. Routing can be Source to Destination or one source to multiple destinations.

Example: Press Destination 1, 2, 4 then press Source 2 will route Input 2 to Output 1, 2, 4 respectfully.

5. EDID MODE SELECT BUTTONS: Used to select EDID mode using Input buttons #1 and #2.

6. IR SENSOR: The IR sensor receives IR commands from the supplied remote controller or third party IR emitter.

7. SOURCE SELECT BUTTONS: Separate inputs 1 thru 4 select buttons are provided each source selection.

8. FUNCTION KEY - ALL: Disables (mute) video on all destinations OR selects the same source to all destinations.



Option 1

- Press **ALL** followed by **OFF** button. The display will show "0" indicating all destinations have no video selected.

Option 2

- Press **ALL** followed by Source **1 THRU 4**. The display will show the Source selected.
- Press **ENTER**. The pre-set source selection will be assigned all destinations.

FRONT PANEL

FRONT PANEL

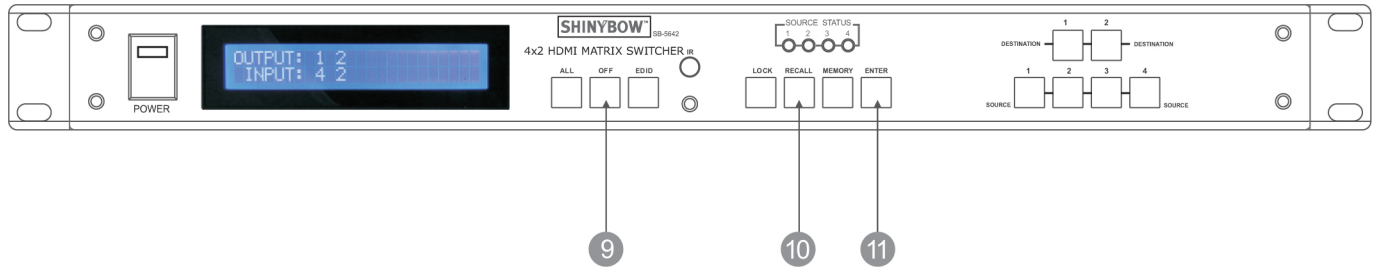

9. FUNCTION KEY - OFF:

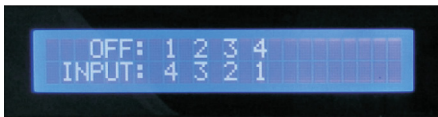

Disables (mutes) video to selected channels. Either destinations.

- Press **OFF** button followed by any destination channel.
- Press **1 THRU 2** output destination. The display will show "0" for the selected channel indicating no video selected.

10. FUNCTION KEY - RECALL:

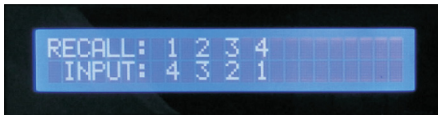

The system will show previously stored presets, up to a total of (8).

Presets are stored in local memory using Source keys 1 thru 4 or Destination keys 1 thru 4 as the memory preset location.

- Press **RECALL** button.
- Press **1 THRU 4** on either Source or Destination row.
- Press **ENTER**. The pre-set configuration will execute.

Operation completes.

Note: Operation will abort if no keys are pressed within 5 seconds.

11. FUNCTION KEY - ENTER: Press **ENTER** to confirm entries.

FRONT PANEL

FRONT PANEL

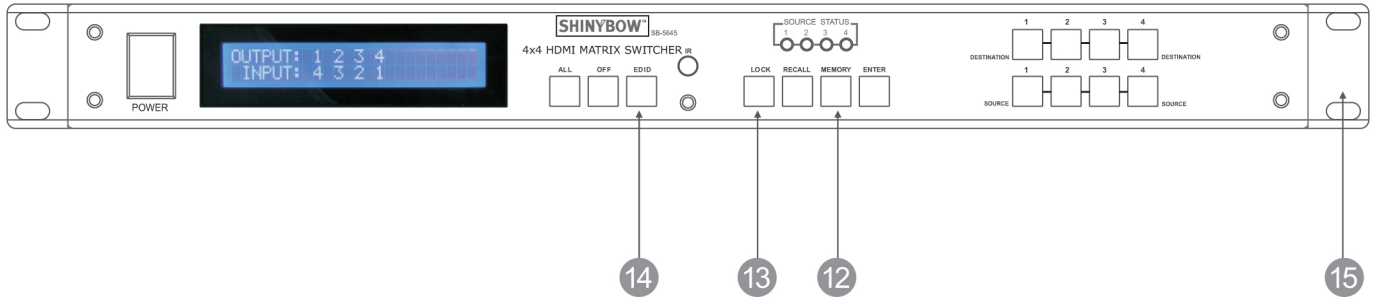

12. FUNCTION KEY - MEMORY:

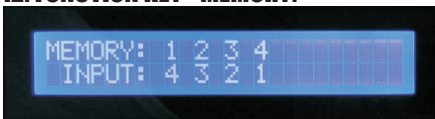

The system will show stored presets, up to a total of (6).

Presets are stored in local memory using Source keys 1 thru 4 or Destination keys 1 thru 2 as the memory preset location.

- Configure desired matrices.
- Press **MEMORY** button.
- Press **1 THRU 4** on Source or **1 THRU 2** on Destination row.
- Press **ENTER** to ready memory location.
- Or press **MEMORY** again to cancel the operation.

Operation completes.

Note: Operation will abort if no keys are pressed within 5 seconds.

13. FUNCTION KEY - LOCK:

- Press and hold **LOCK** button for two seconds lockout the front panel.
- Press and hold **LOCK** button for two seconds to enable the front panel.

14. FUNCTION KEY - EDID:

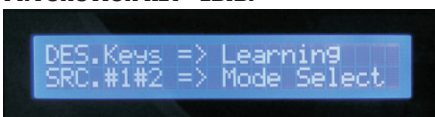

- Press **EDID** to select new EDID mode or select source row #1 or #2 for LINK source EDID again.

15. 19 INCH EAR MOUNT PAIR: Converts desktop to 19 inch rack mount. Bracket (part # 1U-440L) INCLUDED. Image shows rack mount bracket attached.

BACK PANEL

BACK PANEL

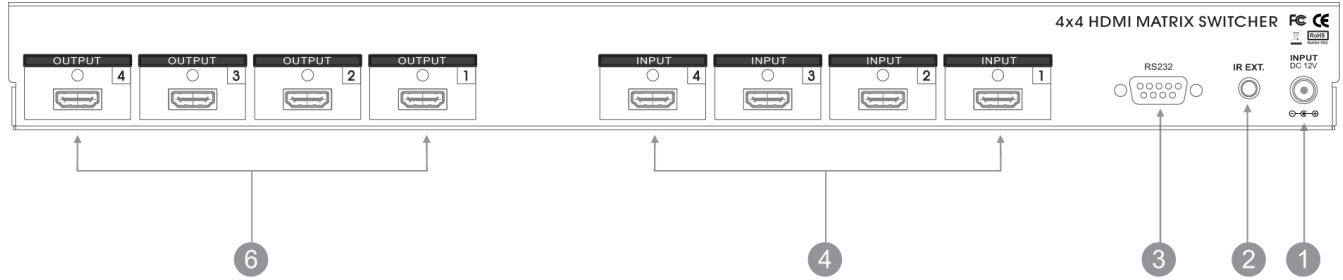

1. DC POWER INLET: The switcher is fitted with a DC power plug input connector. Ensure that the plug used is of an approved type and is of sufficient current carrying connector capacity with the correct voltage and connector polarity. 12Volt DC power supply 3A Max (Center pin positive).



POWER JACK:

DC Jack - Inner OD Ø 2.1mm (+)
Outside OD Ø 5.5mm (GND)
Power input - 12VDC, 3A

2. IR EXTENDER CONTROL: Supports one IR extender. Extends a maximum distance of up to ~1000 feet/300M. When you plug the external IR extender into the switcher, the front panel IR receiver remains active.



IR EXTENDER JACK: Female Jack - inner OD Ø 3.5 mm

3. RS-232 CONNECTION: RS-232 control port to allow for interfacing to a PC Such as a computer or touch panel control, to the switcher via this DB-9pin Female connector for serial RS-232 control.

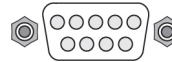

REMOTE PORT: DB-9pin female connector

4. INPUTS - 1, 2, 3 & 4 HDMI: Connects a HDMI digital video/audio signal link direct to the female HDMI connector. This connector supports HDMI digital video/audio and DVI digital video sources. If you remove the HDMI screw posts, you must use the provided HDMI Locking Post replacement screws to keep the internal HDMI jack secure. Removing the HDMI screws without installing the HDMI Locking Post replacement screws will void your warranty.



HDMI DIGITAL VIDEO/AUDIO CONNECTOR:

HDMI female connector.

Note: With the proper adapters, the switcher can be used with DVI digital video signals, as it is HDCP compliant. DVI does not support audio.

HDMI Digital Video/Audio
Connectors with fix screws for Inputs 1~4

5. OUTPUTS- 1, 2, 3 & 4 HDMI: Connects a HDMI digital video/audio signal link direct to the female HDMI connector. This connector supports HDMI digital video/audio and DVI digital video sources. If you remove the HDMI screw posts, you must use the provided HDMI Locking Post replacement screws to keep the internal HDMI jack secure. Removing the HDMI screws without installing the HDMI Locking Post replacement screws will void your warranty.



HDMI DIGITAL VIDEO/AUDIO CONNECTOR:

HDMI female connector.

Note: With the proper adapters, the switcher can be used with DVI digital video signals, as it is HDCP compliant.

HDMI Digital Video/Audio
Connectors with fix screws for Outputs 1~4

REMOTE CONTROL

Before making any connections observe the following:

- Ensure the main voltage supply matches the label on the supplied plug-pack (+/-10%).
- Ensure that the power switch is OFF.
- Ensure that all system grounds (earth) are connected to a common point.
- Avoid powering equipment within a system from multiple power sources that may be separated by large distances.
- Connect all audio video sources and destination equipment.
- Power up all source and destination audio-visual sources.
- For each destination output select the appropriate input source by using the front panel input select buttons. The supplied IR remote control. Or through the RS-232 serial communications port.
- Upon powering up the switcher, it will return to its last used setting before being powered down.

REMOTE CONTROL

1. & 2. SWITCH POWER ON or OFF:

Power ON and OFF

3. DESTINATION: 1 THRU 4 OUTPUT SELECTION:

Destination buttons to select the output display channel

4. SOURCE: 1 THRU 4 INPUT SOURCE SELECTION:

Input 1~4 sources selection buttons

5. FUNCTION KEY: Function selection buttons

ALL DEMO or ENTER
EDID LOCK

6. SELECT EDID MODES: PRESS SOURCE BUTTON 1 THRU 2

1. Mode 1 : FSS® (Fast Speed Start®)
2. Mode 2 : H24-3D
3. Mode 3 : H24M-3D
4. Mode 4 : H36
5. Mode 5 : H36M
6. Mode 6 : H36-3D
7. Mode 7 : H36M-3D
8. Mode 8 : AUTO

IR REMOTE : SW-5645

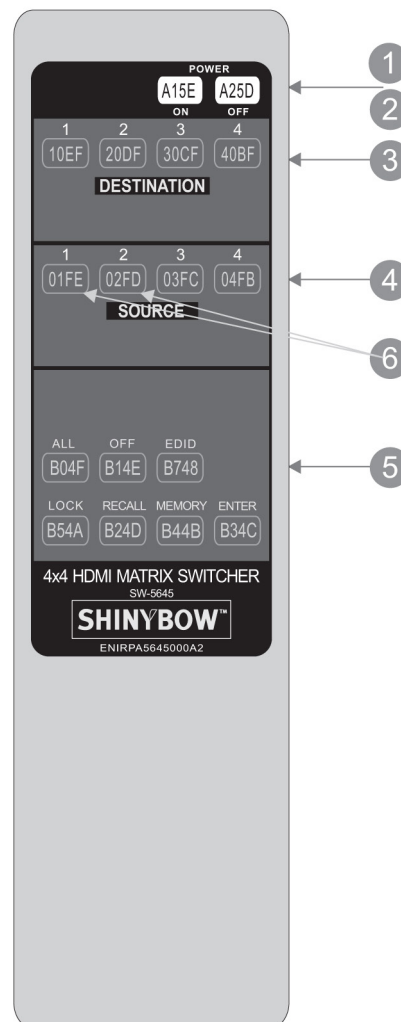

REMOTE PROTOCOL COMMANDS

IR REMOTE CUSTOM AND DATA CODES (NEC Standard)

HOW TO SETUP IR CODES :

CUSTOM CODE : 1CE3

DATA CODE : 1CE3

POWER ON:	1CE3	A15E	LOCK:	1CE3	B54A
POWER OFF:	1CE3	A25D	RECALL:	1CE3	B24D
ALL:	1CE3	B04F	MEMORY:	1CE3	B44B
OFF:	1CE3	B14E	ENTER:	1CE3	B34C
EDID:	1CE3	B748			

PRESS TV DESTINATION - # then PRES AV SOURCE - #

DESTINATION #1 : 1CE3 10EF
DESTINATION #2 : 1CE3 20DF
DESTINATION #3 : 1CE3 30EF
DESTINATION #4 : 1CE3 40DF

SOURCE #1 : 1CE3 01FE
SOURCE #2 : 1CE3 02FD
SOURCE #3 : 1CE3 03FC
SOURCE #4 : 1CE3 04FB

For Example:

Select Destination # 1 to show Source #1~4

The IR Data Code list :

Destination # 1, Source #1 1CE3 10EF 1CE3 01FE
Destination # 1, Source #2 1CE3 10EF 1CE3 02FD
Destination # 1, Source #3 1CE3 10EF 1CE3 03FC
Destination # 1, Source #4 1CE3 10EF 1CE3 04FB

Press EDID Mode key :

Mode 1 : FSS	1CE3	E01F
Mode 2 : H24-3D	1CE3	E11E
Mode 3 : H24M-3D	1CE3	E21D
Mode 4 : H36	1CE3	E31C
Mode 5 : H36M	1CE3	E41B
Mode 6 : H36-3D	1CE3	E51A
Mode 7 : H36M-3D	1CE3	E619
Mode 8 : AUTO	1CE3	E718

RS-232 SERIAL INTERFACE

RS-232 SERIAL INTERFACE CONNECT a PC or CONTROL SYSTEM. VERSION COMPATIBLE V2.0.1

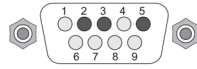

RS-232 SERIAL CONNECT

Pin	RS-232	Definition
1	-----	Not used
2	TX	Transmitter
3	RX	Receiver
4	-----	Not used
5	GND	Ground
6	-----	Not used
7	-----	Not used
8	-----	Not used
9	-----	Not used

RS-232 PROTOCOL COMMANDS (RS-232 CONTROL DRIVER V2.0.1)

The ShinybowUSA switcher can be controlled via the TCP/IP serial control port to allow for interfacing to a PC, or similar third party control system.



The serial communication parameters are 9600 baud, 8 bit, No Parity and 1 stop bit - this is often referred to as 9600 8N1. When the unit recognizes a complete command it will perform the requested action - there is no delimiter character required.

EDID FUNCTION

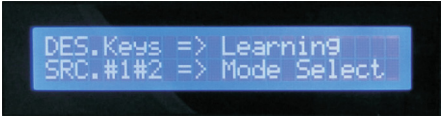
EDID FUNCTION SETUP



EDID SETUP	To Change The EDID Setup
Step 1. Press the EDID button	The display will show the currently selected EDID mode.
Step 2. Press SOURCE #1 OR #2 button row	The button will flash blue and the display will show the current Embedded EDID Status.
Step 3. Press the ENTER button	To set EDID mode. The switcher will return to operation mode.
Operation will abort if no keys are pressed within 5 seconds.	
EMBEDDED EDID MODES	Total 8 EDID Modes
Embedded EDID Setup Press EDID > SOURCE > ENTER SOURCE #1 or SOURCE #2 	To select EDID mode. Repeatedly pressing the SOURCE 1 button will cycle up thru the options. Repeatedly pressing the SOURCE 2 button will cycle down thru the options. Embedded EDID : Mode 1 : FSS® Mode 2 : H24-3D Mode 3 : H24M-3D Mode 4 : H36-3D Mode 5 : H36M-3D Mode 6 : DVI 1280x1024-60Hz Mode 7 : DVI 1920x1200-60Hz Mode 8 : AUTO

EDID FUNCTION FOR HDMI MATRIX SWITCHER

RESET	EDID Return To Factory Default
How to RESET EDID mode Press EDID > RECALL > ENTER  	To RESET to FACTORY DEFAULT (1080p-2CH). Press EDID button: The LCM will show the current EDID status. Press RECALL button: The LCM will show the RESET EDID . Press ENTER to confirm entries. The EDID will return to FSS® mode and resolution 1080p-2CH.
EDID STATUS	To View The Current EDID Status
Step 1. Press EDID button	The button will flash blue and the display will show the current Embedded EDID Status.
Step 2. Press EDID button	To exit.
HOW TO SETUP FSS® FUNCTION	Fast Speed Start®
Step 1. Press the DESTINATION #1~4 button row Then Press the SOURCE #1~4 button row	To setup and Install all devices.
Step 2. Press EDID button	Select a optimum status of Embedded EDID mode.
Step 3. Press ENTER button	To confirm entries.
Step 4. Press EDID button	To select the EDID FSS® mode.
Step 5. Press ENTER button	To confirm entries.

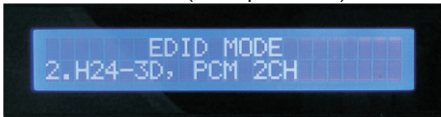
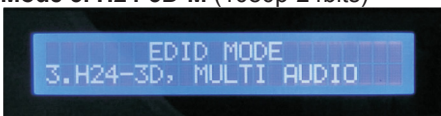
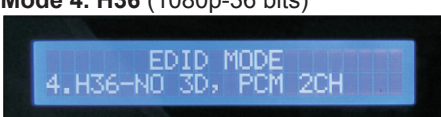
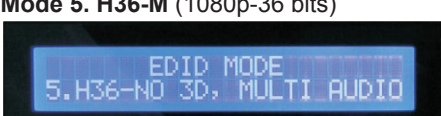

EDID FUNCTION

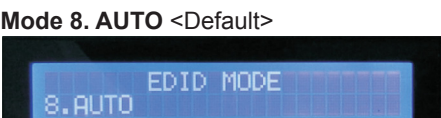
EDID FUNCTION: (8) EMBEDDED EDID MODES

EDID FUNCTION: (8) EMBEDDED EDID MODES	
<p>Mode 1. FSS® (Fast Speed Start®)</p> 	<p>Fast Speed Start® mode shortens the startup time of the switcher. Selecting this mode does not force the EDID setup to be cancelled. Users may first select one EDID mode from mode 2 to 3, and then select mode 1 for fast speed start®.</p>
<p>Mode 2. H24-3D (1080p-24 bits)</p> 	<p>Audio Support: PCM 2CH</p>
<p>Mode 3. H24-3D-M (1080p-24bits)</p> 	<p>Audio Support: MAT(MLP) 7.1CH, PCM 2CH, One Bit Audio 2CH, AC-3 5.1CH, DTS 5.1CH, PCM 7.1CH, Dolby Digital + 7.1CH, DTS-HD 7.1CH</p>
<p>Mode 4. H36 (1080p-36 bits)</p> 	<p>Audio Support: PCM 2CH</p>
<p>Mode 5. H36-M (1080p-36 bits)</p> 	<p>Audio Support: MAT(MLP) 7.1CH, PCM 2CH, One Bit Audio 2CH, AC-3 5.1CH, DTS 5.1CH, PCM 7.1CH, Dolby Digital + 7.1CH, DTS-HD 7.1CH</p>
<p>Mode 6. H36-3D (1080p-36 bits)</p> 	<p>Audio Support: PCM 2CH</p>
<p>Mode 7. H36-3D-M (1080p-36bits)</p> 	<p>Audio Support: MAT(MLP) 7.1CH, PCM 2CH, One Bit Audio 2CH, AC-3 5.1CH, DTS 5.1CH, PCM 7.1CH, Dolby Digital + 7.1CH, DTS-HD 7.1CH</p>
<p>Mode 8. AUTO <Default></p> 	<p>All Outputs will be set to the highest common resolution of all connected display devices.</p>

EDID FUNCTION

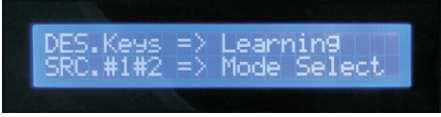
EDID FUNCTION FOR HDMI MATRIX SWITCHER

LEARNING EDID	Learning EDID From Destination To Source
<p>Learning EDID setup Press EDID > DESTINATION > SOURCE > ENTER</p>  	<p>Press EDID > DESTINATION Button</p> <p>The LCM will be show LEARNING. The switcher will LEARN destination HDMI EDID and pass the selected source.</p> <p>Learning EDID setup for HDMI Key Press Sequence: EDID > DESTINATION # > SOURCE # > ENTER The EDID for HDMI has been learned.</p>
<p>NOTE: The already learned EDID cannot be modified. You can only rebuild a new Learning EDID. For Example: When the Source has “Learned” the EDID data from a destination, it will save that EDID information into EPROM and the EDID data cannot change. Please select new learning destination to sources or change to one of the embedded EDID modes when you want to remove the learning EDID memory from EPRPM.</p>	
LEARNING EDID SINGLE TO SINGLE	Learning Destination #2 EDID To Source #3
Step 1. Press EDID button	The button will flash blue and the display will show the current Embedded EDID Status.
Step 2. Press the DESTINATION #2 button row	Copy the Destination #2 Display EDID.
Step 3. Press the SOURCE #3 button row	Learning the Destination #2 EDID To Source # 3.
Step 4. Press ENTER button	To confirm entries.
LEARNING EDID SINGLE TO MULTIPLE	Learning Destination EDID Link To The Majority Sources
Step 1. Press EDID button	The button will flash blue and the display will show the current Embedded EDID Status.
Step 2. Press the DESTINATION #2 button row	Copy any 1~2 Destinations EDID.
Step 3. Press the SOURCE #1, #3, #4 button row	Learning the Destination EDID link to source #1, #3, #4.
Step 4. Press ENTER button	To confirm entries.
LEARNING EDID SINGLE TO ALL	Learning Destination EDID Link To All Sources
Step 1. Press EDID button	The button will flash blue and the display will show the current Embedded EDID Status.
Step 2. Press destination button 1 THRU 2	Learning anyone 1~2 Destination EDID to all sources.
Step 3. Press ALL button	Learning selected destination EDID to all sources.
Step 4. Press ENTER button	To confirm entries.
LEARNING EDID DEFINITION	Learning EDID From Destination To Source
<p>1. The switcher will LEARN the destination EDID and pass to the selected source. 2. To set up learning between a single destination and single source: Press EDID button > Press DESTINATION 1 THRU 2 > Press SOURCE 1 THRU 4 > Press ENTER to confirm. The switcher will learn the destination EDID for the source device. 3. To set up learning between a single destination and multiple sources: Press EDID button > Press DESTINATION 1 THRU 2 > Press the majority SOURCES 1 THRU 4 > Press ENTER. The switcher will learn the single destination EDID to many source devices. 4. How to Learn single destinations with all sources. Press EDID button > Press ALL button > Press ENTER to confirm.</p>	
AUTO MODE DEFINITION	Common Resolution And Audio
<p>The switcher will find the highest common Resolution and Audio from all destination EDID to link Source. Example for Single Source: DESTINATION > Press #1 and then SOURCE > Press #1 Destination. Device #1 will set to the highest common resolution and Audio of source #1 Example for Multiple Sources: Destination device #1, #2 will be set to the highest common resolution and Audio available and source device #1 will output this same resolution.</p>	

IR EXTENDER

1. SB-100 IR 300M Receiver

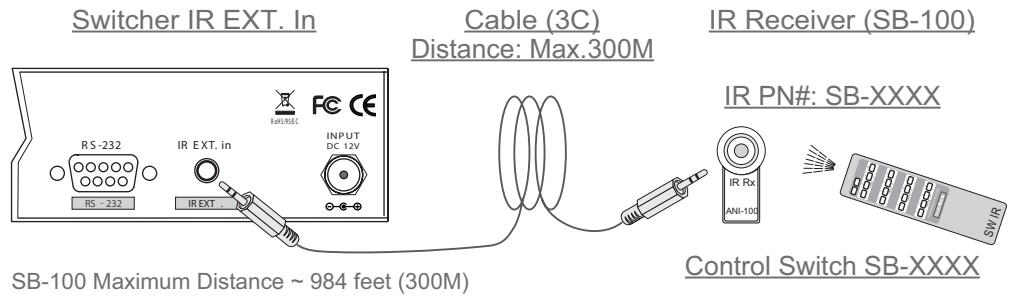

The SB-100 IR Receiver is required when using the port "ALL in" Jack.

2. SB-100C IR 2M Receiver

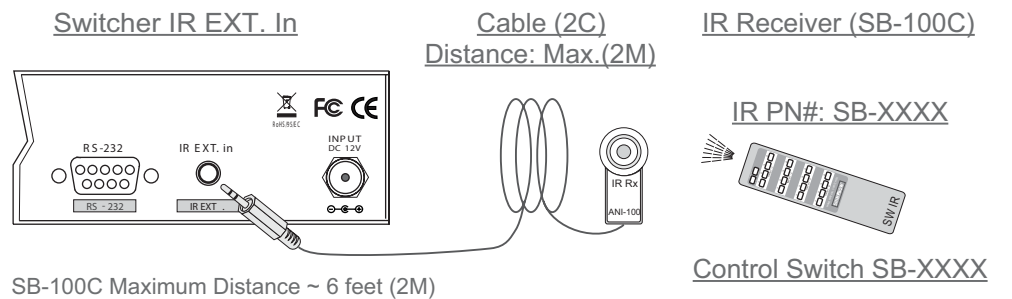

The SB-100C IR Receiver will not function on the port "ALL in" Jack.

*** When you plug the External IR extender into the switcher, the front panel IR receiver remains active. ***

Pin configuration for IR 984 feet (300M) Extender Receiver such as SB-100 compatible



Tip: Signal
Ring :VCC
Sleeve: GND

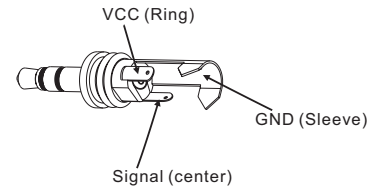
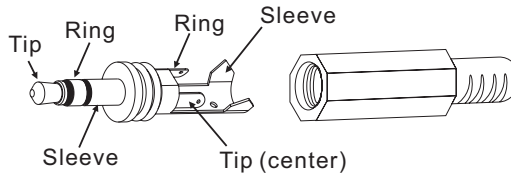

SB-100 Receiver and SB-101 Transmitter The DISTANCE maximum ~ 984 feet (300M)

Pin configuration for IR Receiver 6 feet (2M) cable such as SB-100C compatible



Tip: Signal
Ring: NC
Sleeve: GND

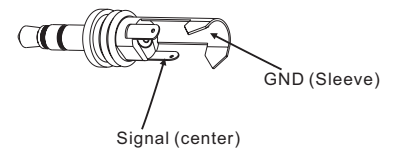
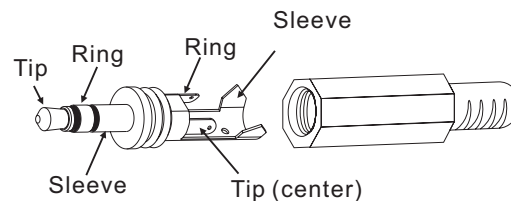

SB-100 Receiver and SB-101C Transmitter The DISTANCE maximum ~ 984 feet (300M)

Note: The External IR jack has voltage on the "Ring" portion of a 3-conductor plug. You must use a 3-conductor plug (aka: stereo plug). Using a 2-conductor plug will short out the power supply. Always make connections with the switcher power off.

TYPICAL APPLICATION

INSTALLING DIAGRAM

Sample Connection:

Using IR Transmitters (SB-101) and IR Receivers (SB-100) with SB-6335T & SB-6335R to control a projector.

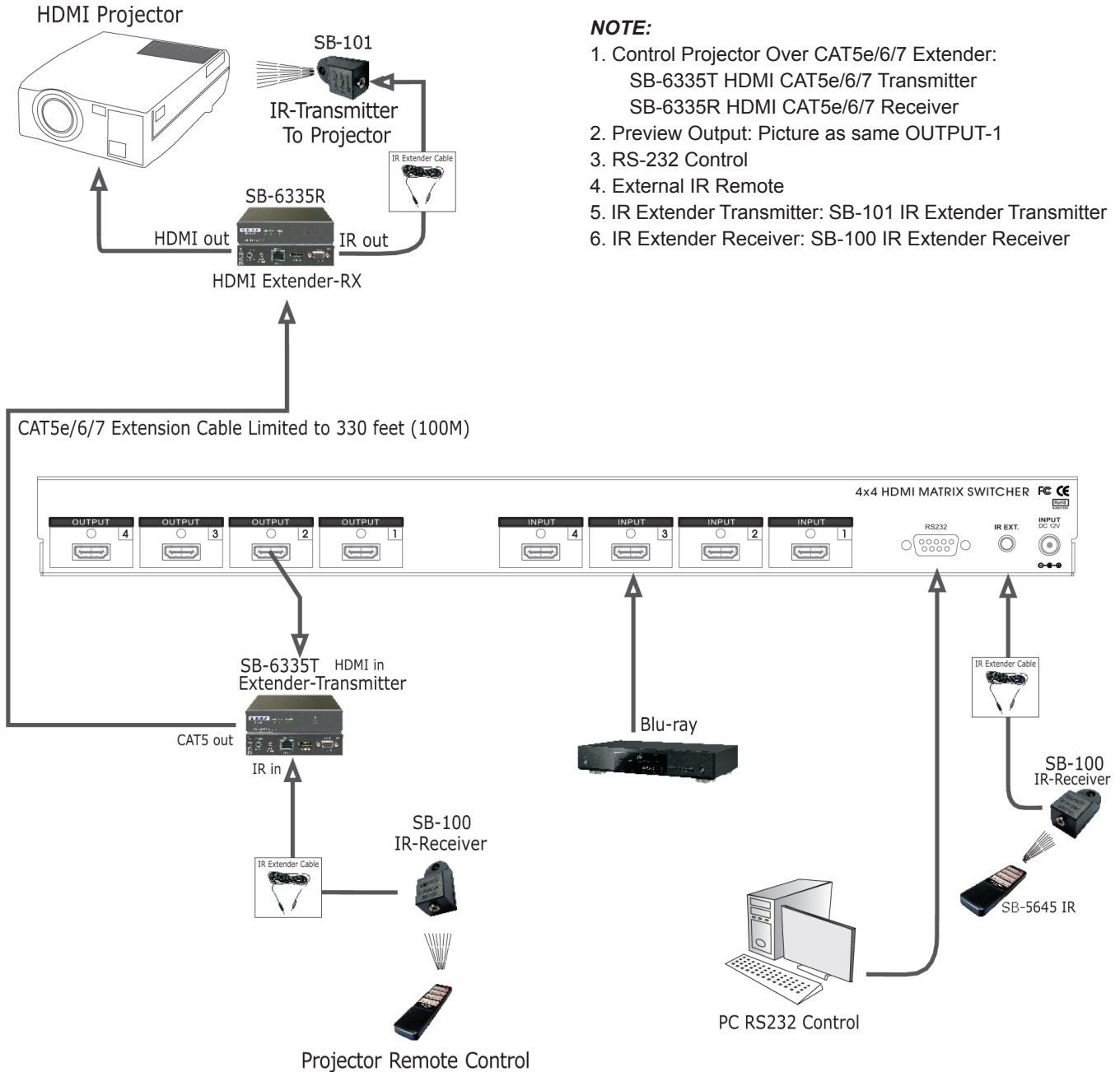

NOTE:

1. Control Projector Over CAT5e/6/7 Extender:
SB-6335T HDMI CAT5e/6/7 Transmitter
SB-6335R HDMI CAT5e/6/7 Receiver
2. Preview Output: Picture as same OUTPUT-1
3. RS-232 Control
4. External IR Remote
5. IR Extender Transmitter: SB-101 IR Extender Transmitter
6. IR Extender Receiver: SB-100 IR Extender Receiver

Supports HDBase™ extender via SB-6335T Transmitter and SB-6335R Receiver via a CAT5e/6/7 cable.

TYPICAL APPLICATION

INSTALLING DIAGRAM

Sample Connection:

Using IR Transmitters (SB-101) and IR Receivers (SB-100) with SB-6335T and SB-6335R to control a Satellite Receiver.

NOTE :

1. Control Satellite Receiver Over HDMI CAT5e/6/7
Extender from room:
SB-6335T HDMI CAT5e/6/7 Transmitter
SB-6335R HDMI CAT5e/6/7 Receiver
2. Audio Extractor to Recode Audio:
SB-5609 HDMI Audio Extractor
3. Control HDMI ARC: SB-5610 ARC Control Box
4. IR Extender Transmitter: SB-101 IR Extender Transmitter
5. IR Extender Receiver: SB-100 IR Extender Receiver

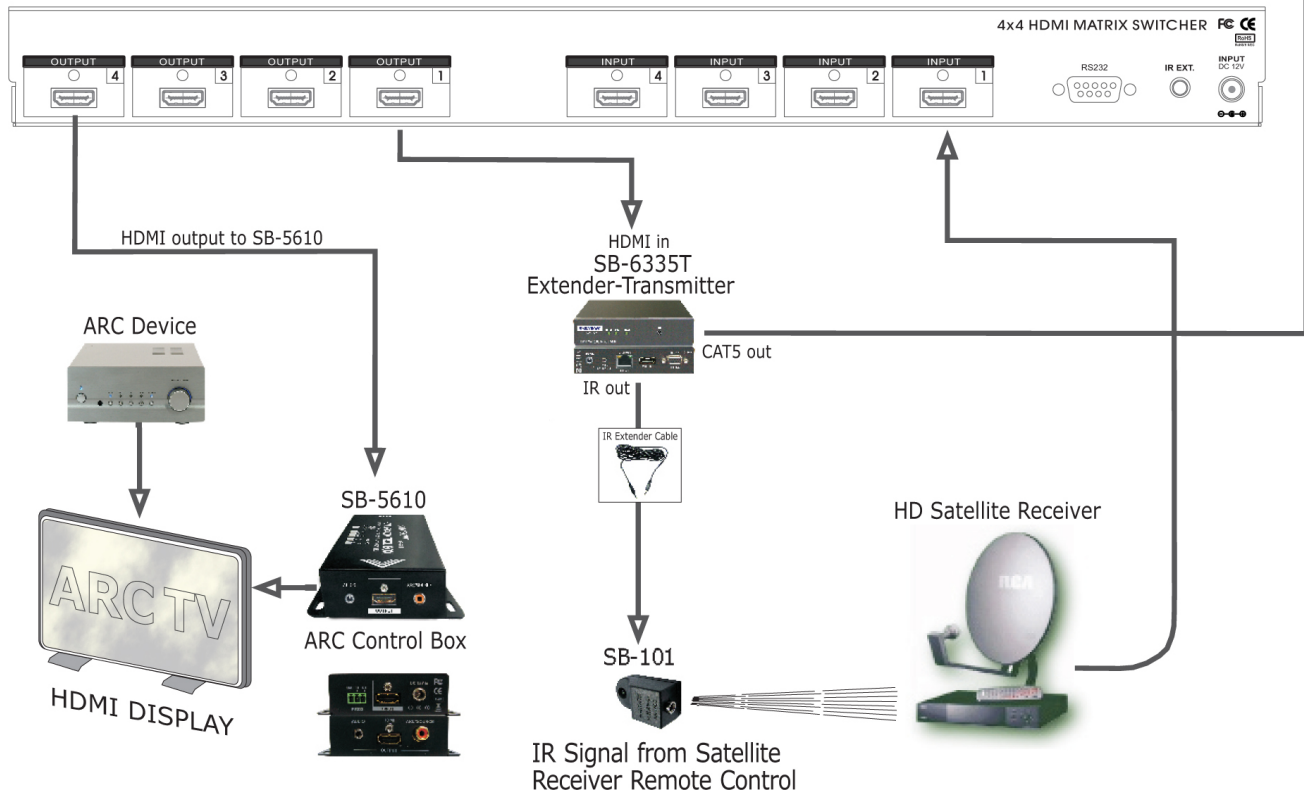
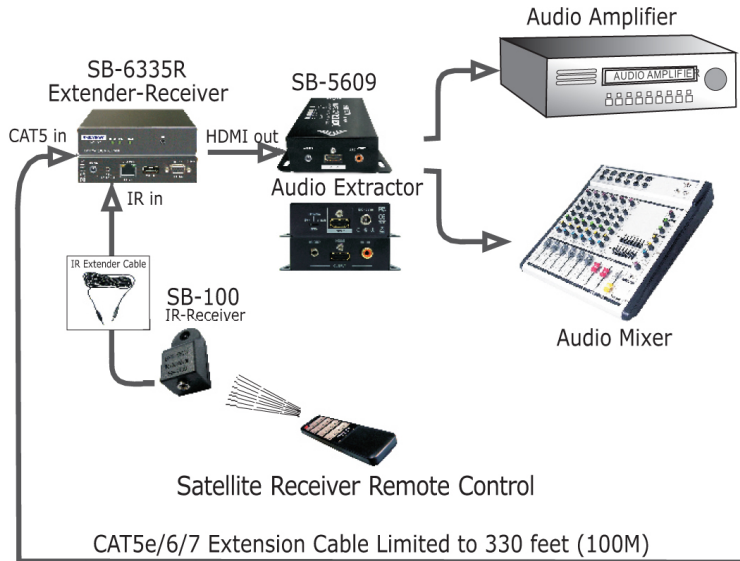

Supports HDBaseT™ extender via the SB-6335T Transmitter and SB-6335R Receiver via a CAT5e/6/7 cable

LIMITED WARRANTY

PLEASE READ THE FOLLOWING TERMS AND CONDITIONS CAREFULLY BEFORE USING THIS HARDWARE, COMPONENTS AND SOFTWARE PROVIDED BY, THROUGH OR UNDER SHINYBOWUSA, INC (COLLECTIVELY, THE "PRODUCT"). By using installing or using the Product, you unconditionally signify your agreement to these Terms and Conditions. If you do not agree to these Terms and Conditions, do not use the Product and return the Product to SHINYBOWUSA, Inc. at the return address set forth on the Product's packing label at your expense. SHINYBOWUSA, Inc. may modify these Terms and Conditions at anytime, without notice to you.

RESTRICTIONS ON USE OF THE PRODUCT

It is your responsibility to read and understand the installation and operation instructions, both verbal and in writing, provided to you with respect to the Product. You are authorized to use the Product solely in connection with such instructions. Any use of the Product not in accordance with such instructions shall void any warranty pertaining to the Product. Any and all damages that may occur in the use of the Product that is not strictly in accordance with such instructions shall be borne by you and you agree to indemnify and hold harmless SHINYBOWUSA, Inc. from and against any such damage.

The Product is protected by certain intellectual property rights owned by or licensed to SHINYBOWUSA. Any intellectual property rights pertaining to the Product are licensed to you by SHINYBOWUSA, Inc. and/or its affiliates, including any manufacturers or distributors of the Product (collectively, "SHINYBOWUSA") for your personal use only, provided that you do not change or delete any proprietary notices that may be provided with respect to the Product.

The Product is sold to you and any use of any associated intellectual property is deemed to be licensed to you by SHINYBOWUSA for your personal use only. SHINYBOWUSA does not transfer either the title or the intellectual property rights to the Product and SHINYBOWUSA retains full and complete title to the intellectual property rights therein. All trademarks and logos are owned by SHINYBOWUSA or its licensors and providers of the Product, and you may not copy or use them in any manner without the prior written consent of SHINYBOWUSA, which consent may be withheld at the sole discretion of SHINYBOWUSA.

The functionality and usability of the Product is controlled by SHINYBOWUSA, Inc. from its offices within the State of Texas, United States of America. SHINYBOWUSA makes no representation that materials pertaining to the Product are appropriate or available for use in other locations other than the shipping address you provided with respect thereto. You are advised that the Product may be subject to U.S. export controls.

DISCLAIMERS AND LIMITATION OF LIABILITY

SHINYBOWUSA may change or modify the Product at any time, from time to time.

THE PRODUCT IS PROVIDED "AS IS" AND WITHOUT WARRANTIES OF ANY KIND EITHER EXPRESS OR IMPLIED. SHINYBOWUSA DOES NOT WARRANT OR MAKE ANY REPRESENTATIONS REGARDING THE USE OR THE RESULTS OF THE USE OF THE PRODUCT'S CORRECTNESS, ACCURACY, RELIABILITY, OR OTHERWISE.

SHINYBOWUSA has no duty or policy to update any information or statements pertaining to the Product and, therefore, such information or statements should not be relied upon as being current as of the date you use the Product. Moreover, any portion of the materials pertaining to the Product may include technical inaccuracies or typographical errors. Changes may be made from time to time without notice with respect to the Product.

TO THE FULLEST EXTENT PERMISSIBLE PURSUANT TO APPLICABLE LAW, SHINYBOWUSA DISCLAIMS ALL WARRANTIES, EXPRESS OR IMPLIED, INCLUDING, BUT NOT LIMITED TO IMPLIED WARRANTIES OF MERCHANTABILITY, FITNESS FOR A PARTICULAR PURPOSE AND NON-INFRINGEMENT. SHINYBOWUSA DOES NOT WARRANT THE ACCURACY, COMPLETENESS OR USEFULNESS OF ANY INFORMATION WITH RESPECT TO THE PRODUCT. SHINYBOWUSA DOES NOT WARRANT THAT THE FUNCTIONS PERTAINING TO THE PRODUCT WILL BE ERROR-FREE, THAT DEFECTS WITH RESPECT TO THE PRODUCT WILL BE CORRECTED, OR THAT THE MATERIALS PERTAINING THERETO ARE FREE OF DEFECTS OR OTHER HARMFUL COMPONENTS. SHINYBOWUSA WILL USE ITS REASONABLE EFFORTS TO CORRECT ANY DEFECTS IN THE PRODUCT UPON TIMELY WRITTEN NOTICE FROM YOU NOT TO EXCEED 10 BUSINESS DAYS AFTER RECEIPT BY YOU OF THE PRODUCT, BUT YOU (AND NOT SHINYBOWUSA) ASSUME THE ENTIRE COST OF ALL NECESSARY SERVICING, REPAIR AND CORRECTION THAT WAS CAUSED BY YOU UNLESS OTHERWISE AGREED TO IN A SEPARATE WRITING BY SHINYBOWUSA.

UNDER NO CIRCUMSTANCES, INCLUDING, BUT NOT LIMITED TO, NEGLIGENCE, SHALL SHINYBOWUSA BE LIABLE FOR ANY SPECIAL OR CONSEQUENTIAL DAMAGES THAT RESULT FROM THE USE OF, OR THE INABILITY TO USE THE PRODUCT IN ACCORDANCE WITH ITS SPECIFICATIONS, EVEN IF SHINYBOWUSA OR ITS REPRESENTATIVES HAVE BEEN ADVISED OF THE POSSIBILITY OF SUCH DAMAGES. IN NO EVENT SHALL SHINYBOWUSA'S TOTAL LIABILITY TO YOU FROM ALL DAMAGES, LOSSES, AND CAUSES OF ACTION (WHETHER IN CONTRACT, OR OTHERWISE) EXCEED THE AMOUNT YOU PAID TO SHINYBOWUSA, IF ANY, FOR THE PRODUCT.

END OF DOCUMENT

122 Rose Ln. Suite 303 | Frisco, Texas 75034

1-877-SHINY-USA

1-877-744-6987

1-972-377-2508

sales@shinybowusa.com

www.shinybowusa.com

SHINYBOW™ USA
MULTIMEDIA AUDIO AND VISUAL